

DIGITAL POWER AMPLIFIER

MX-D1

SERVICE MANUAL

IMPORTANT NOTICE

This manual has been provided for the use of authorized YAMAHA Retailers and their service personnel. It has been assumed that basic service procedures inherent to the industry, and more specifically YAMAHA Products, are already known and understood by the users, and have therefore not been restated.

WARNING: Failure to follow appropriate service and safety procedures when servicing this product may result in personal injury, destruction of expensive components, and failure of the product to perform as specified. For these reasons, we advise all YAMAHA product owners that any service required should be performed by an authorized YAMAHA Retailer or the appointed service representative.

IMPORTANT: The presentation or sale of this manual to any individual or firm does not constitute authorization, certification or recognition of any applicable technical capabilities, or establish a principle-agent relationship of any form.

The data provided is believed to be accurate and applicable to the unit(s) indicated on the cover. The research, engineering, and service departments of YAMAHA are continually striving to improve YAMAHA products. Modifications are, therefore, inevitable and specifications are subject to change without notice or obligation to retrofit. Should any discrepancy appear to exist, please contact the distributor's Service Division.

WARNING: Static discharges can destroy expensive components. Discharge any static electricity your body may have accumulated by grounding yourself to the ground buss in the unit (heavy gauge black wires connect to this buss).

IMPORTANT: Turn the unit OFF during disassembly and part replacement. Recheck all work before you apply power to the unit.

■ CONTENTS

TO SERVICE PERSONNEL	2~3	PROTECTION INFORMATION /	
FRONT PANEL	4	プロテクション情報	17~18
REAR PANELS	4~5	IC DATA	19~21
SPECIFICATIONS	6	BLOCK DIAGRAM	22~23
INTERNAL VIEW	7	PRINTED CIRCUIT BOARD	24~33
SERVICE PRECAUTIONS / サービス時の注意事項	8~10	PIN CONNECTION DIAGRAM	34
DISASSEMBLY PROCEDURES / 分解手順	11~14	SCHEMATIC DIAGRAM	35~37
TROUBLE SHOOTING / 故障チェック方法	15~16	PARTS LIST	39~54



このサービスマニュアルは、エコマーク認定の再生紙を使用しています。
This Service Manual uses recycled paper.

100869



YAMAHA
YAMAHA CORPORATION
P.O.Box 1, Hamamatsu, Japan

MX-D1

■ TO SERVICE PERSONNEL

1. Critical Components Information

Components having special characteristics are marked  and must be replaced with parts having specifications equal to those originally installed.

2. Leakage Current Measurement (For 120V Models Only)

When service has been completed, it is imperative to verify that all exposed conductive surfaces are properly insulated from supply circuits.

- Meter impedance should be equivalent to 1500 ohm shunted by 0.15µF.

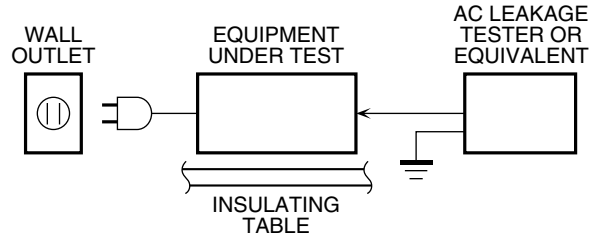

- Leakage current must not exceed 0.5mA.
- Be sure to test for leakage with the AC plug in both polarities.



“CAUTION”

“F501: FOR CONTINUED PROTECTION AGAINST RISK OF FIRE, REPLACE ONLY WITH SAME TYPE 20A, 250V FUSE.”

CAUTION

F501: REPLACE WITH SAME TYPE 20A, 250V FUSE.

ATTENTION

F501: UTILISER UN FUSIBLE DE RECHANGE DE MEME TYPE DE 20A, 250V.

WARNING: CHEMICAL CONTENT NOTICE!

The solder used in the production of this product contains LEAD. In addition, other electrical/electronic and/or plastic (where applicable) components may also contain traces of chemicals found by the California Health and Welfare Agency (and possibly other entities) to cause cancer and/or birth defects or other reproductive harm.

DO NOT PLACE SOLDER, ELECTRICAL/ELECTRONIC OR PLASTIC COMPONENTS IN YOUR MOUTH FOR ANY REASON WHATSOEVER!

Avoid prolonged, unprotected contact between solder and your skin! When soldering, do not inhale solder fumes or expose eyes to solder/flux vapor!

If you come in contact with solder or components located inside the enclosure of this product, wash your hands before handling food.

About lead-free solder / 無鉛ハンダについて

The foil side of all P.C.B.s used for this product are soldered with lead-free soldering material which is an alloy of Sn+Ag+Cu (tin + silver + copper).

However, the surface mount devices on the component side of the MAIN P.C.B. and OPERATION P.C.B. are soldered with the lead solder.

Among some types of lead-free solder currently available, it is recommended to use one of the following types for the repair work.

- Sn + Ag + Cu (tin + silver + copper)
- Sn + Cu (tin + copper)
- Sn + Zn + Bi (tin + zinc + bismuth)

Caution:

1. As the melting point temperature of the lead-free solder is about 30°C to 40°C (50°F to 70°F) higher than that of the lead solder, be sure to use a soldering iron suitable to each solder.
2. If lead solder must be used, be sure to remove lead-free solder from each terminal section of the parts to be replaced and from the area around it completely before soldering, or make sure that the lead-free solder and lead solder melt together fully.

この製品に使用されているすべての基板のハンダ面のハンダ付けには、Sn+Ag+Cu(錫+銀+銅)の合金である無鉛ハンダが使用されています。

ただし、MAIN P.C.B.部品面およびOPERATION P.C.B.部品面の表面実装部品のハンダ付けには、鉛入りハンダが使用されています。

無鉛ハンダにはいくつかの種類がありますが、修理時には下記のような無鉛ハンダの使用を推奨します。

- ・ Sn+Ag+Cu(錫+銀+銅)
- ・ Sn+Cu(錫+銅)
- ・ Sn+Zn+Bi(錫+亜鉛+ビスマス)

注意：

- ① 無鉛ハンダの融点温度は通常の鉛入りハンダに比べ30～40℃程度高くなっていますので、それぞれのハンダに合ったハンダごてをご使用ください。
- ② 鉛入りハンダを使わざるを得ない場合は、あらかじめ交換する部品端子部やその周辺部の無鉛ハンダをすべて取り除くか、あるいは無鉛ハンダと鉛入りハンダが十分に溶けた状態となるようにハンダ付けしてください。

DIMENSIONS / 寸法図

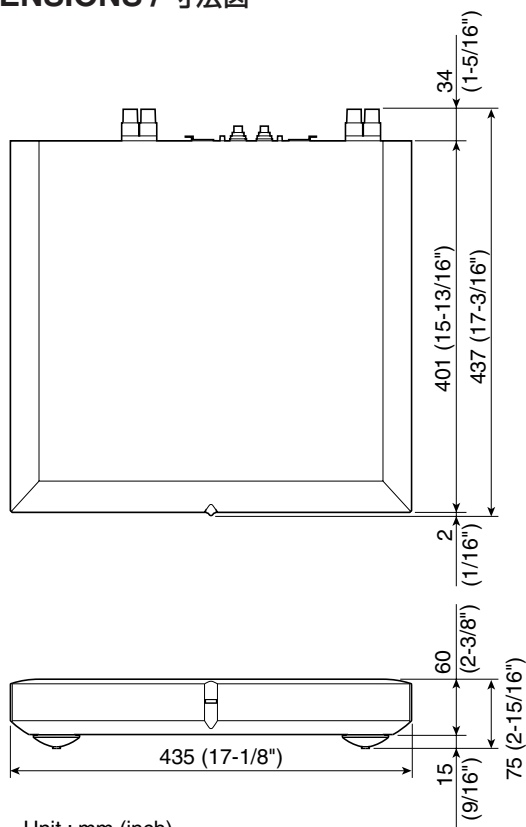

FRONT PANEL

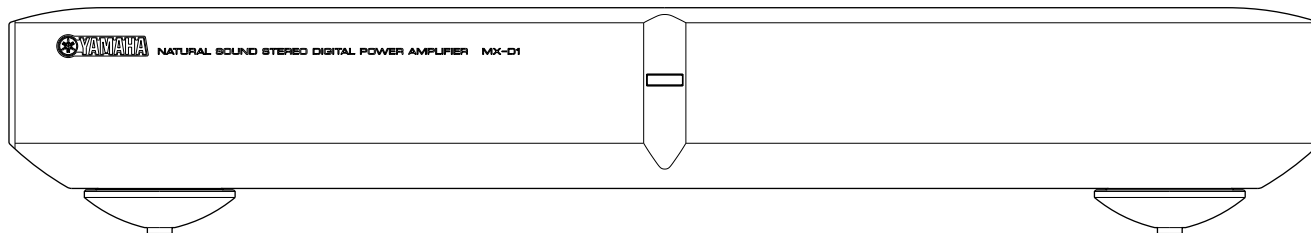

REAR PANELS

U, C models

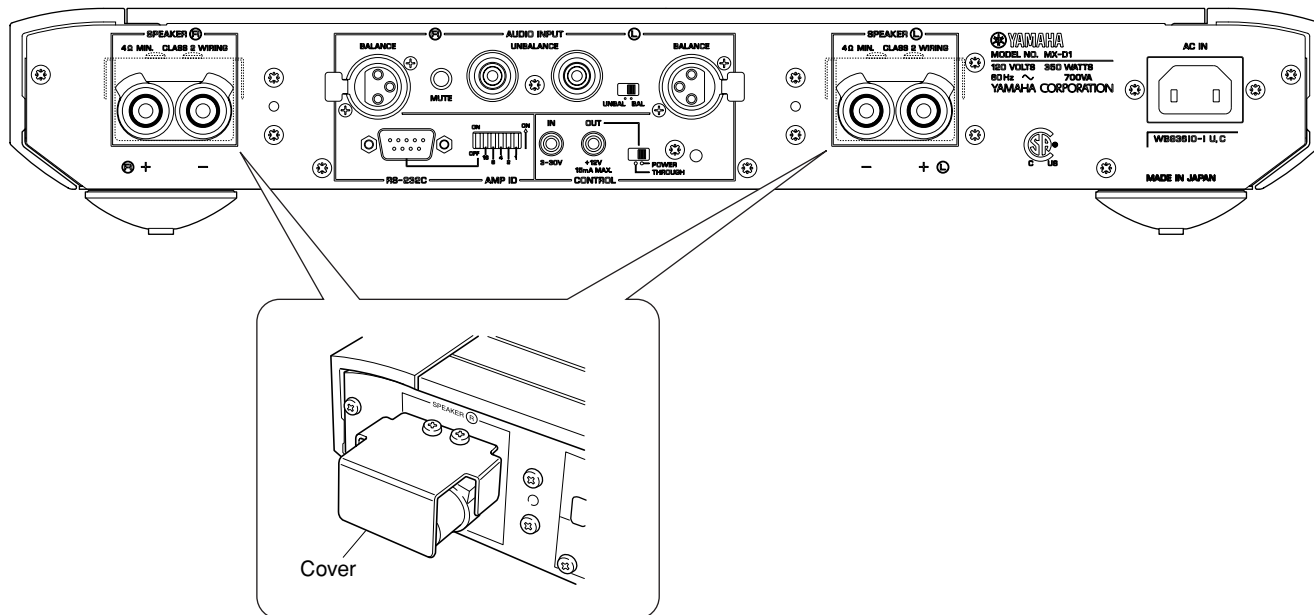

A model

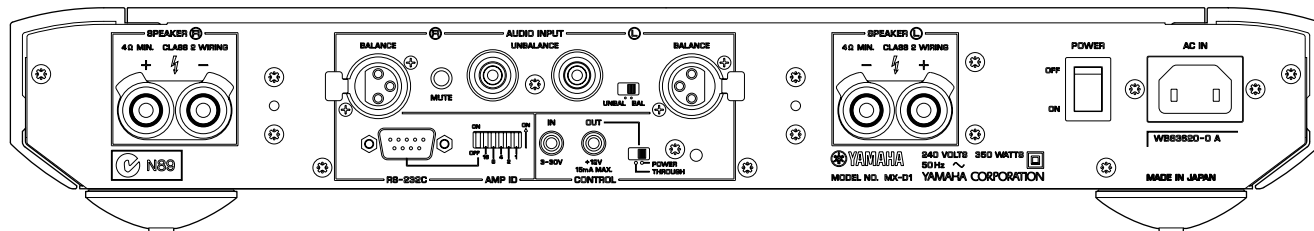

B, G models

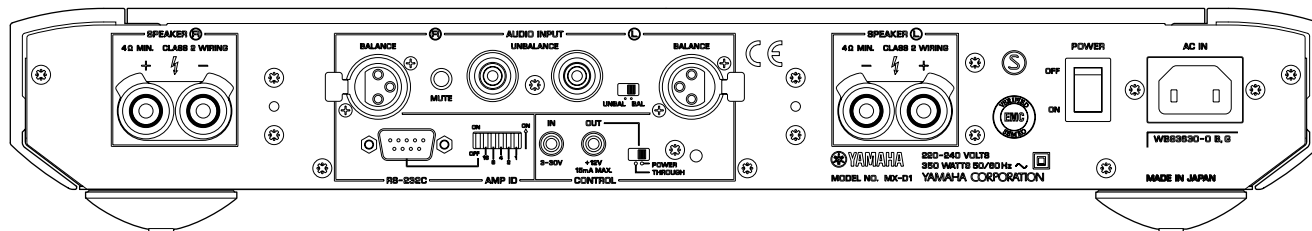

T model

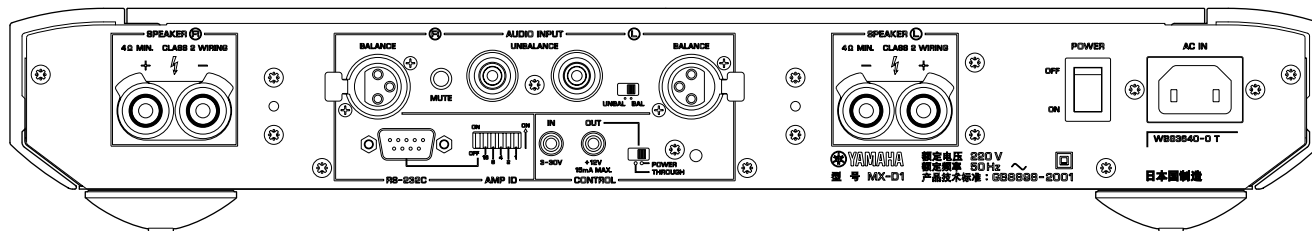

K model

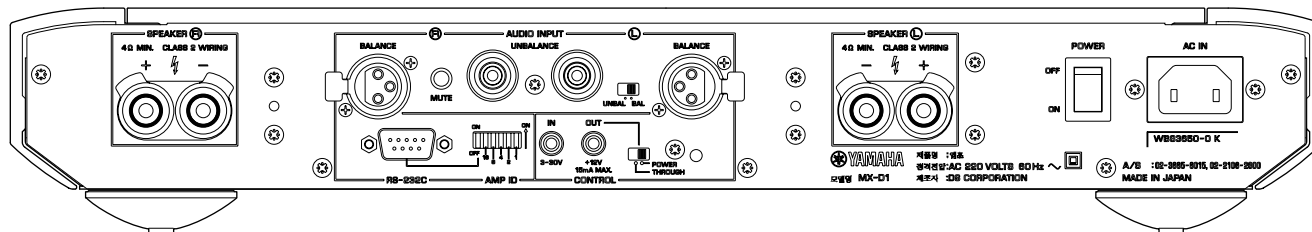

J model

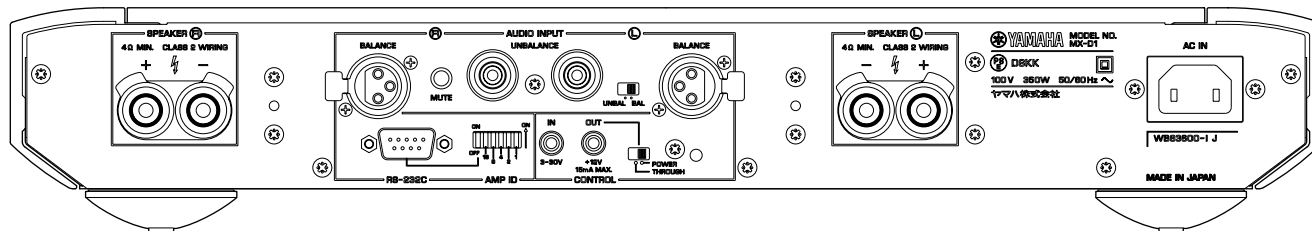

MX-D1

■ SPECIFICATIONS / 参考仕様

Minimum RMS Output Power / 定格出力

(1 kHz, 1% THD)	
U, C models (8 ohms)	500 W + 500 W
A, B, G, T, K, J models (4 ohms to 8 ohms) ...	500 W + 500 W

Dynamic Power Per Channel / ダイナミックパワー (IHF)

8/6/4/2 ohms	700/850/1000/1000 W
--------------------	---------------------

Dynamic Headroom / ダイナミックヘッドルーム

8/6/4 ohms	1.5/2.3/3.0 dB
------------------	----------------

Damping Factor / ダンピングファクタ

1 kHz, 8 ohms	more than 200
---------------------	---------------

Input Sensitivity / Input Impedance (入力感度/入力インピーダンス)

UNBALANCE	1.3 V / 25 k-ohms
BALANCE	2.2 V / 10 k-ohms

Frequency Response / 周波数特性

1 Hz to 100 kHz	± 3.0 dB
10 Hz to 20 kHz	± 0.5 dB

Total Harmonic Distortion / 全高調波歪率

(1 kHz, 10 W/ 8 ohms, 20 kHz LPF)	
UNBALANCE	less than 0.002 %
BALANCE	less than 0.002 %

Signal to Noise Ratio / 信号対雑音比 (IHF-A network)

(Input shorted, 20 kHz LPF)	
UNBALANCE	more than 120 dB
BALANCE	more than 120 dB

Channel Separation / チャンネルセパレーション

(Input 5.1 k-ohms shorted, 1 kHz)	
UNBALANCE	more than 100 dB
BALANCE	more than 100 dB

Muting / ミューティング

.....	- ∞
-------	-----

Power Supply / 電源電圧

U, C models	AC 120 V, 60 Hz
A model	AC 240 V, 50 Hz
B, G models	AC 230 V, 50 Hz
T model	AC 220 V, 50 Hz
K model	AC 220 V, 60 Hz
J model	AC 100V, 50/60 Hz

Power Consumption / 消費電力

U, C models	350 W
A, B, G, T, K models	350 W
J model	350 W

Standby Power Consumption (Reference Data) / 待機時消費電力(参考値)

.....	less than 0.1 W
-------	-----------------

Dimensions / 寸法 (W x H x D)

.....	435 x 75 x 437 mm (17-1/8" x 2-15/16" x 17-3/16")
-------	---

Weight / 重量

.....	10.4 kg (22 lbs. 15 oz.)
-------	--------------------------

Accessories / 付属品

Power Cable x 1
Clamp Filter with Fixing Tie (for Power Cable) x 2
Clamp Filter (for RS-232C Interface Cable) x 1
Clamp Filter (for Control Cable) x 2 [U, C models]
Clamp Filter (for Audio Pin Cable) x 1 [U, C models]

* Specifications are subject to change without notice due to product improvements.

※ 参考仕様および外観は予告なく変更されることがあります。

U	U.S.A. model	C	Canadian model
A	Australian model	B	British model
G	European model	T	Chinese model
K	Korean model	J	Japanese model

INTERNAL VIEW

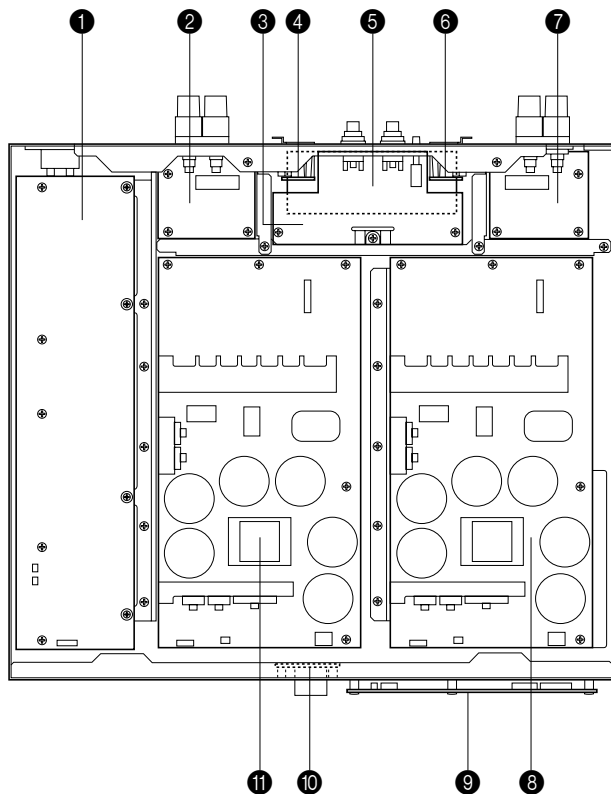

- ❶ FUNCTION (1) P.C.B.
- ❷ FUNCTION (4) P.C.B.
- ❸ FUNCTION (3) P.C.B.
- ❹ FUNCTION (6) P.C.B.
- ❺ FUNCTION (2) P.C.B.
- ❻ FUNCTION (7) P.C.B.
- ❼ FUNCTION (5) P.C.B.
- ❽ MAIN (R) P.C.B.
- ❾ OPERATION (1) P.C.B.
- ❿ OPERATION (2) P.C.B.
- ⓫ MAIN (L) P.C.B.

■ SERVICE PRECAUTIONS / サービス時の注意事項

1. Safety measures

- Some internal parts in this product contain high voltages and are dangerous. Be sure to take safety measures during servicing, such as wearing insulating gloves.
- Note that C196, C197, C198, C199, C222 and C223 are dangerous even after the power is turned off because an electric charge remains and a high voltage continues to exist there.

Before starting the service work, connect discharging resistors (5 k-ohms/10 W) to the terminals indicated in the figure below to discharge electricity. The time required for discharging is about 30 seconds. (at 4 locations for Lch and Rch, each)

1. 安全対策

- この製品の内部には高電圧部分があり危険です。修理の際は、絶縁性の手袋を使用するなどの安全対策を行ってください。
- C196、C197、C198、C199、C222、C223には電源をOFFにした後も電荷が残り、高電圧が維持されており危険です。
修理作業前に放電用抵抗(5kΩ/10W)を下記の端子間に接続して放電してください。放電所用時間は約30秒間です。(Lch、Rchに各4箇所あります。)

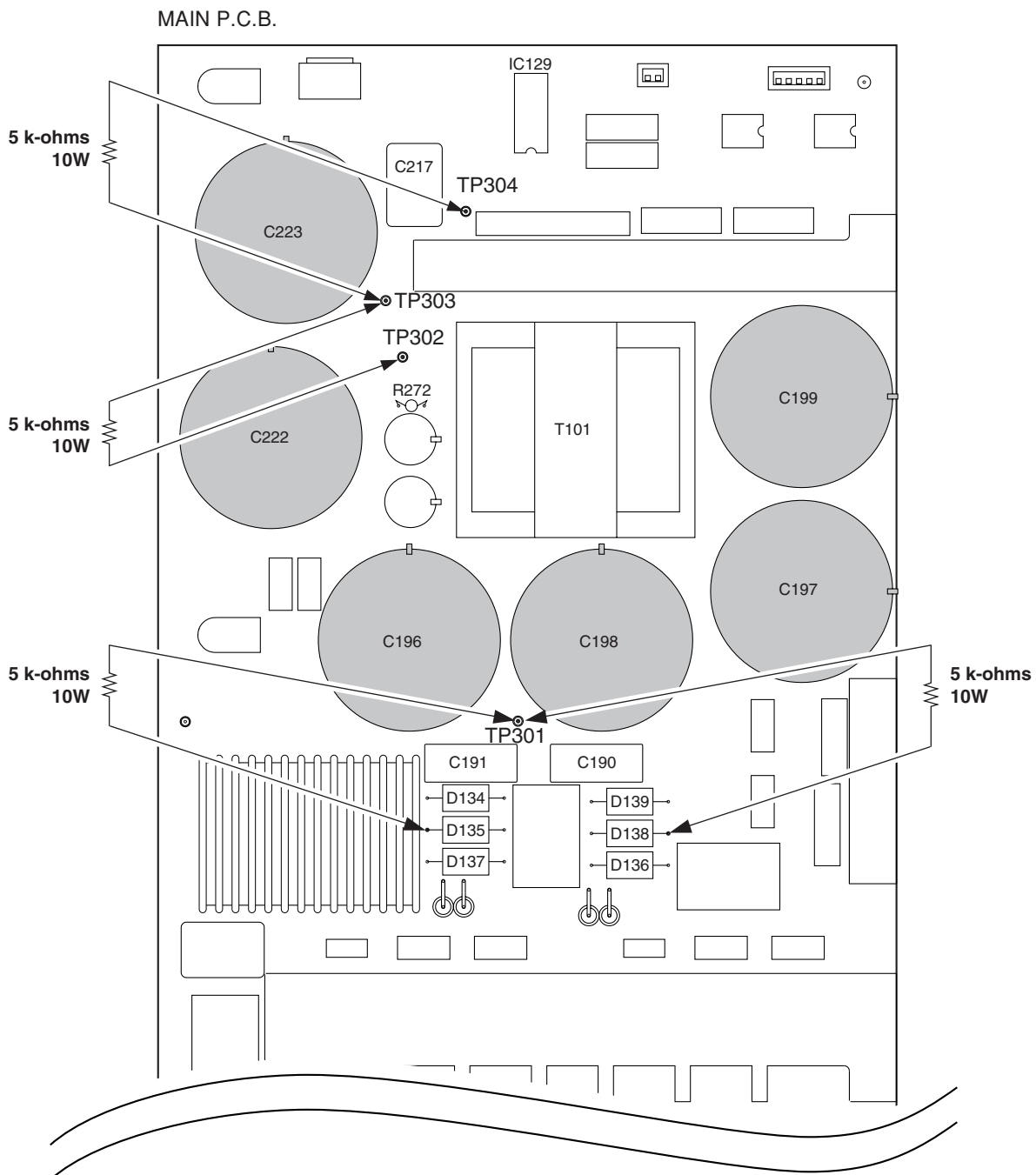

3. Confirming insulation of FET

When the FETs (Q117 to Q120) of the MAIN P.C.B. were removed, be sure to check using the tester that the metal part of each FET itself is insulated from the FET mounting screw after reinstalling them.

3. FETの絶縁確認

MAIN P.C.B.のFET(Q117~Q120)を取り外した場合、組立後に必ずテスターを使用してFET本体金属部分とFET取り付けネジとの間が絶縁されていることを確認してください。

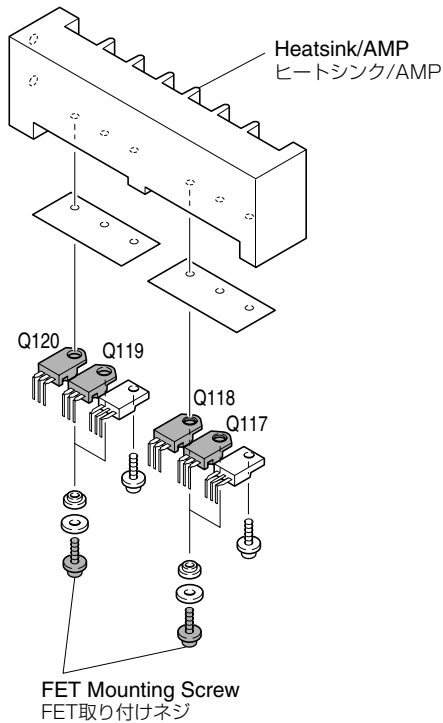

4. Confirming insulation between Heatsink/AMP and chassis

When the Heatsink/AMP mounting screws were removed, be sure to check using the tester that the Heatsink/AMP is insulated from the Frame after reinstalling them.

4. ヒートシンク/AMPとシャーシ間の絶縁確認

ヒートシンク/AMPをフレームに取り付けているネジを外した場合、組立後に必ずテスターを使用してヒートシンク/AMPとフレームとの間が絶縁されていることを確認してください。

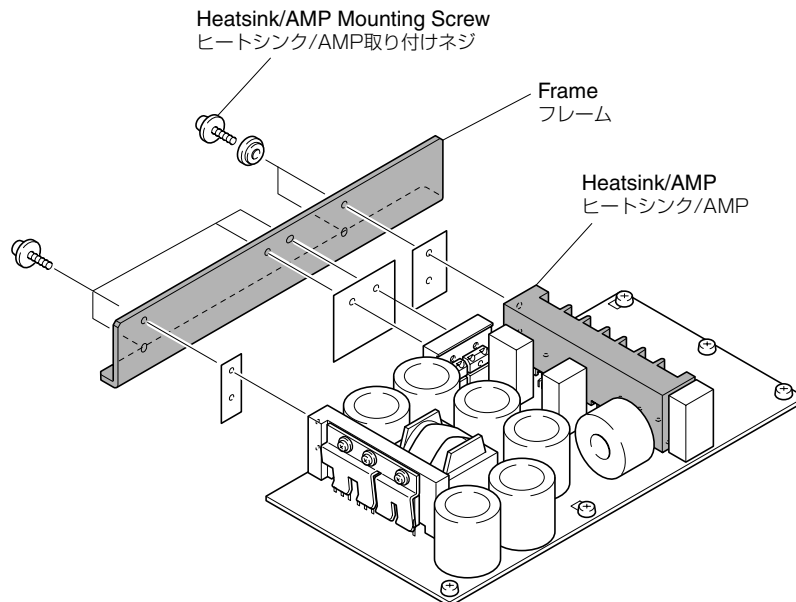

■ DISASSEMBLY PROCEDURES / 分解手順

(Remove parts in the order as numbered.)
Disconnect the power cable from the AC outlet.

1. Removal of Bottom Cover

- Spread a soft cloth and place the unit upside down on it.
- Remove 11 screws (①) and then remove the Bottom Cover. (Fig. 1)

2. Removal of Front Panel, Side Panels and Top Panels

- Remove 4 screws (②) and 3 screws (③). (Fig. 1)
- Set the main unit with its top facing up and remove 4 screws (④). (Fig. 2)
- Remove the Front Panel, Side Panel and Top Panel together by sliding them toward the front. (Fig. 2)

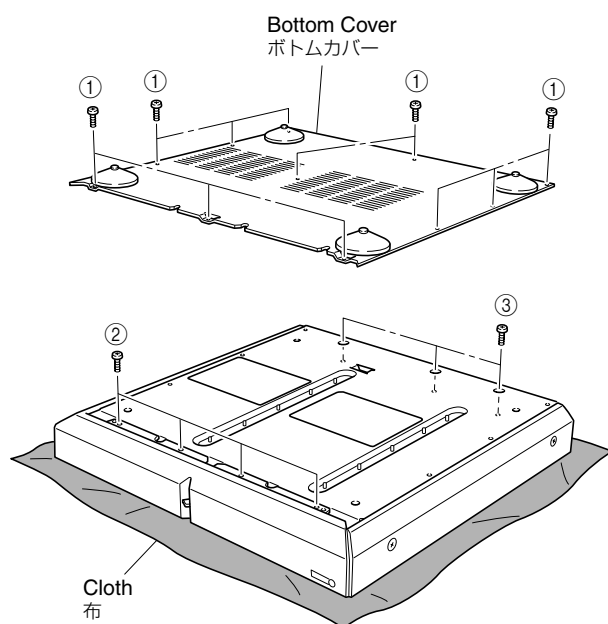

Fig. 1

(番号順に部品を取り外してください。)
AC電源コンセントから、電源コードを抜いてください。

1. ボトムカバーの外し方

- 柔らかい布を敷き、その上に本機を反転して置きます。
- ①のネジ11本を外し、ボトムカバーを取り外します。(Fig. 1)

2. フロントパネル、サイドパネル、トップパネルの外し方

- ②のネジ4本、③のネジ3本を外します。(Fig. 1)
- 本機を上向きにして、④のネジ4本を外します。(Fig. 2)
- フロントパネル、サイドパネル、トップパネル一体をフロント方向にスライドさせて取り外します。(Fig. 2)

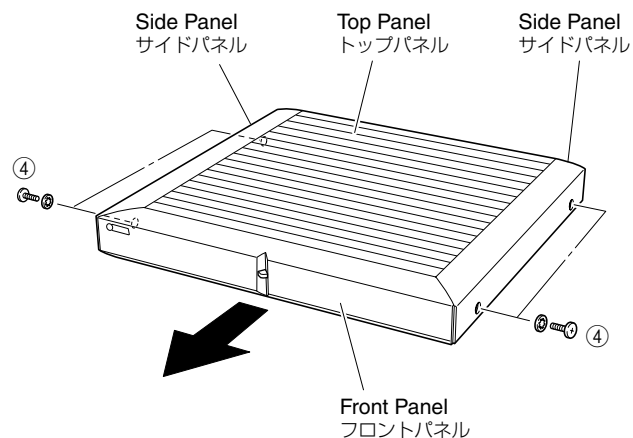

Fig. 2

3. Discharging Capacitor

Refer to "SERVICE PRECAUTIONS" on page 8.

3. コンデンサーの放電

8ページの“サービス時の注意事項”を参照

4. Removal of MAIN (R) P.C.B.

- Remove 5 screws (⑤) and 5 screws (⑥). (Fig. 3)
- Remove the connectors (CB101 to CB108) on the MAIN (R) P.C.B. (Fig. 3)
- Remove the MAIN (R) P.C.B. upward.

5. Removal of FUNCTION (1) P.C.B.

- Remove 4 screws (⑦) and 5 screws (⑧). (Fig. 3)
- Remove the connectors (CB504, CB505) on the FUNCTION (1) P.C.B. (Fig. 3)
- Remove the FUNCTION (1) P.C.B. upward.

6. Removal of MAIN (L) P.C.B.

- Remove 5 screws (⑨), 6 screws (⑩) and 2 screws (⑪). (Fig. 4)
- Remove the connectors (CB101 to CB108) on the MAIN (L) P.C.B. (Fig. 4)
- Release the angle catching the MAIN (L) P.C.B. and remove it upward.

4. MAIN (R) P.C.B.の外し方

- ⑤のネジ5本、⑥のネジ5本を外します。(Fig. 3)
- MAIN (R) P.C.B.上のコネクタ(CB101~CB108)を外します。(Fig. 3)
- MAIN (R) P.C.B.を上方に取り外します。

5. FUNCTION (1) P.C.B.の外し方

- ⑦のネジ4本、⑧のネジ5本を外します。(Fig. 3)
- FUNCTION (1) P.C.B.上のコネクタ(CB504、CB505)を取り外します。(Fig. 3)
- FUNCTION (1) P.C.B.を上方に取り外します。

6. MAIN (L) P.C.B.の外し方

- ⑨のネジ5本、⑩のネジ6本、⑪のネジ2本を外します。(Fig. 4)
- MAIN(L) P.C.B.上のコネクタ(CB101~CB108)を外します。(Fig. 4)
- MAIN (L) P.C.B.をアングルの引っかかりをずらし、上方に取り外します。

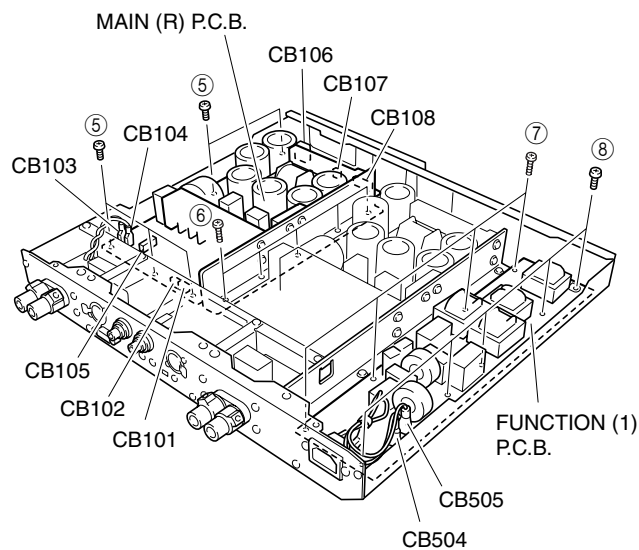

Fig. 3

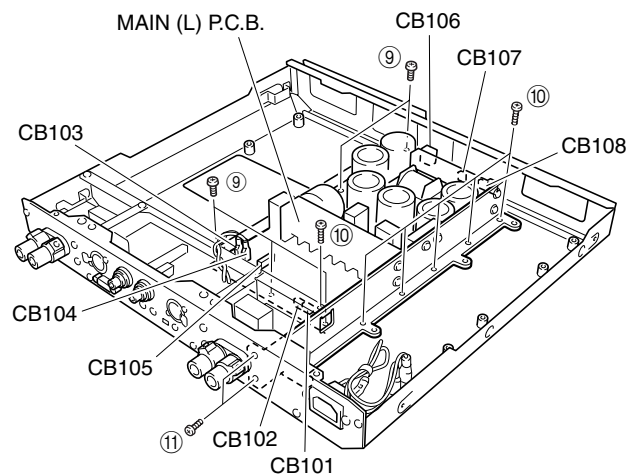

Fig. 4

7. Removal of FUNCTION (5) P.C.B.

- Remove 4 screws (12). (Fig. 5)
- Remove the FUNCTION (5) P.C.B. upward.

8. Removal of FUNCTION (4) P.C.B.

- Remove 4 screws (13). (Fig. 5)
- Remove the FUNCTION (4) P.C.B. upward.

7. FUNCTION (5) P.C.B.の外し方

- ⑫のネジ4本を外します。(Fig. 5)
- FUNCTION (5) P.C.B.を上方に取り外します。

8. FUNCTION (4) P.C.B.の外し方

- ⑬のネジ4本を外します。(Fig. 5)
- FUNCTION (4) P.C.B.を上方に取り外します。

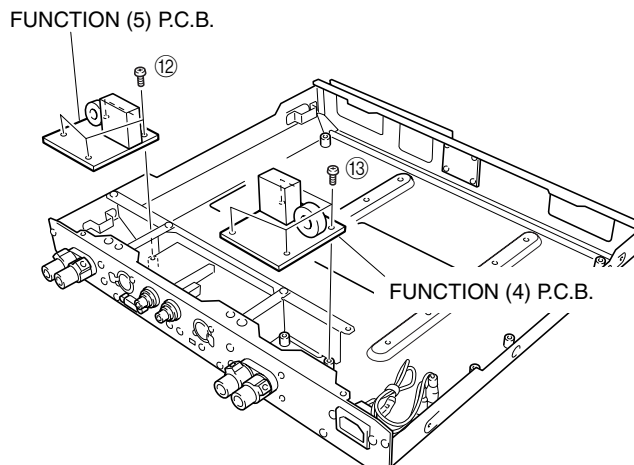

Fig. 5

When checking the P.C.B.:

- Put the Rubber Sheet and a Cloth over the equipment. Then place the P.C.B. upright on the Cloth and check it. (Fig. 6)
- Set the MAIN (L) P.C.B. upright using a non-conductive support, such as wood. (Fig. 6)
- Reconnect all cables (connectors) that have been disconnected.
- When the FUNCTION (2) P.C.B. and FUNCTION (3) P.C.B. are removed from the chassis, they do not work because their grounding are disconnected. Be sure to connect the ground of FUNCTION (2) P.C.B. and FUNCTION (3) P.C.B. to the chassis respectively with a jumper wire or the like.

P.C.B.チェックをする場合には

- 本機の上にゴムシートと布を敷き、その上にP.C.B.を立ててチェックします。(Fig. 6)
- MAIN (L) P.C.B.は、枕木を使って立てます。(Fig. 6)
- 外したケーブル(コネクター)をすべて接続してください。
- FUNCTION (2) P.C.B.およびFUNCTION (3) P.C.B.をシャーシから取り外すとアースが浮いて動作しませんので、FUNCTION (2) P.C.B.およびFUNCTION (3) P.C.B.のアースをリード線等でシャーシに接続してください。

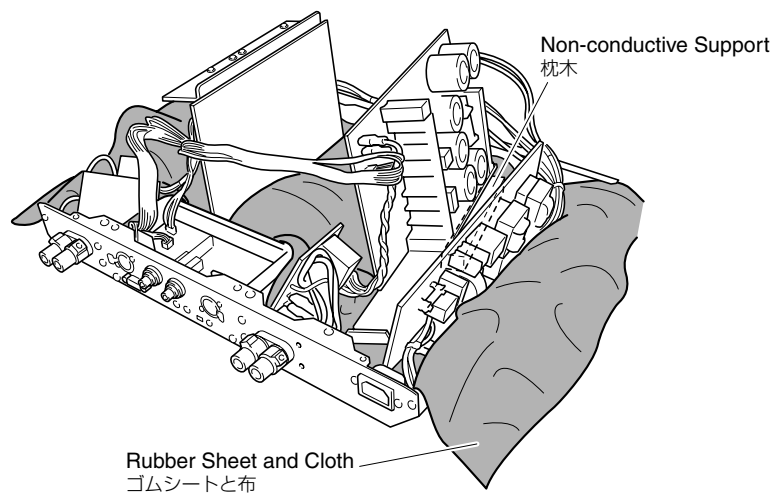

Fig. 6

9. Removal of FUNCTION (2), (3), (6) and (7) P.C.B.s

- a. Remove the connector (CB101) on the MAIN (R) and MAIN (L) P.C.B.s. (Fig. 7)
- b. Remove the connectors (CB501, CB502) on the FUNCTION (3) P.C.B. (Fig. 7)
- c. Remove the connectors (CB701, CB702) on the OPERATION (1) P.C.B. (Fig. 7)
- d. Remove 2 screws (14). (Fig. 7)
- e. Remove 11 screws (15). (Fig. 7)
- f. Remove the Rear Panel rearward.
- g. Remove the nut (16) of the pin jack (UNBALANCE). (Fig. 9)

Note: When removing the nut, cover it with cloth and turn it with pliers so as not to cause damage to it. (Fig. 8)

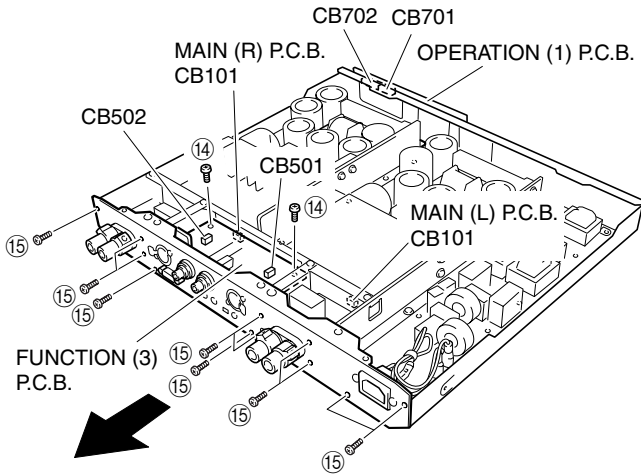

Fig. 7

9. FUNCTION (2), (3), (6), (7) P.C.B.の外し方

- a. MAIN (R)およびMAIN (L) P.C.B.上のコネクタ(CB101)を外します。(Fig. 7)
- b. FUNCTION (3) P.C.B.上のコネクタ(CB501、CB502)を外します。(Fig. 7)
- c. OPERATION (1) P.C.B.上のコネクタ(CB701、CB702)を外します。(Fig. 7)
- d. 14のネジ2本を取り外します。(Fig. 7)
- e. 15のネジ11本を外します。(Fig. 7)
- f. リアパネルをリア方向にスライドします。
- g. ピンジャック入力端子(UNBALANCE)のナット16を外します。(Fig. 9)

注: ナットを外すときはナットを傷つけないように布で覆いその上からペンチを使ってナットを回します。(Fig. 8)

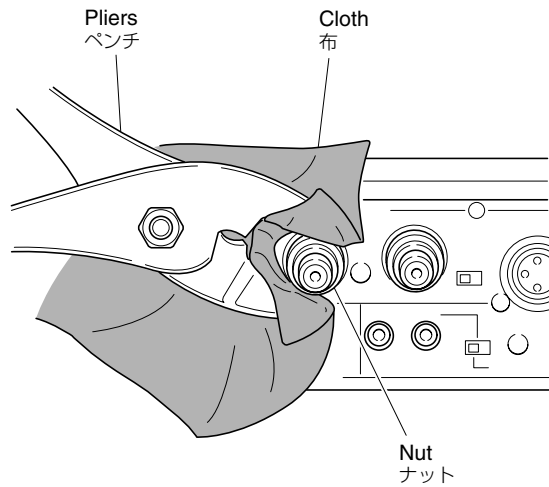

Fig. 8

- h. Remove 1 screw (17). (Fig. 9)
- i. Remove the FUNCTION (3) P.C.B. upward.
- j. Remove 1 screw (18) and 2 Lock Screws (19). (Fig. 9)
- k. Remove the FUNCTION (2) P.C.B. upward.
- l. Remove 2 screws (20). (Fig. 9)
- m. Remove the FUNCTION (6) P.C.B. upward.
- n. Remove 2 screws (21). (Fig. 9)
- o. Remove the FUNCTION (7) P.C.B. upward.

- h. 17のネジ1本を外します。(Fig. 9)
- i. FUNCTION (3) P.C.B.を上方向に取り外します。
- j. 18のネジ1本と19のロックネジ2本を外します。(Fig. 9)
- k. FUNCTION (2) P.C.B.を上方向に取り外します。
- l. 20のネジ2本を外します。(Fig. 9)
- m. FUNCTION (6) P.C.B.を上方向に取り外します。
- n. 21のネジ2本を外します。(Fig. 9)
- o. FUNCTION (7) P.C.B.を上方向に取り外します。

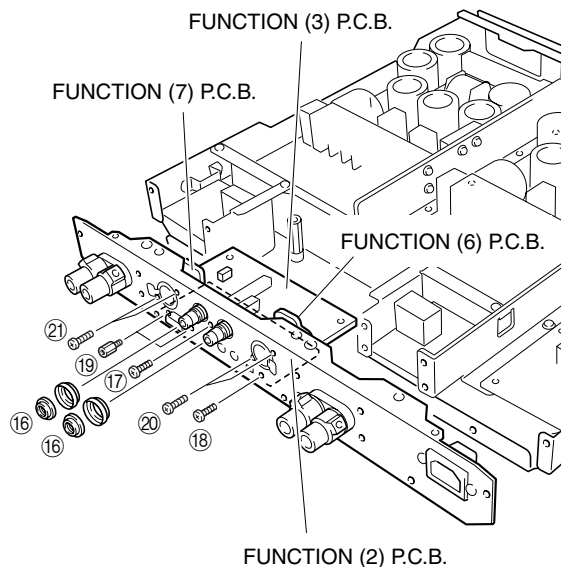
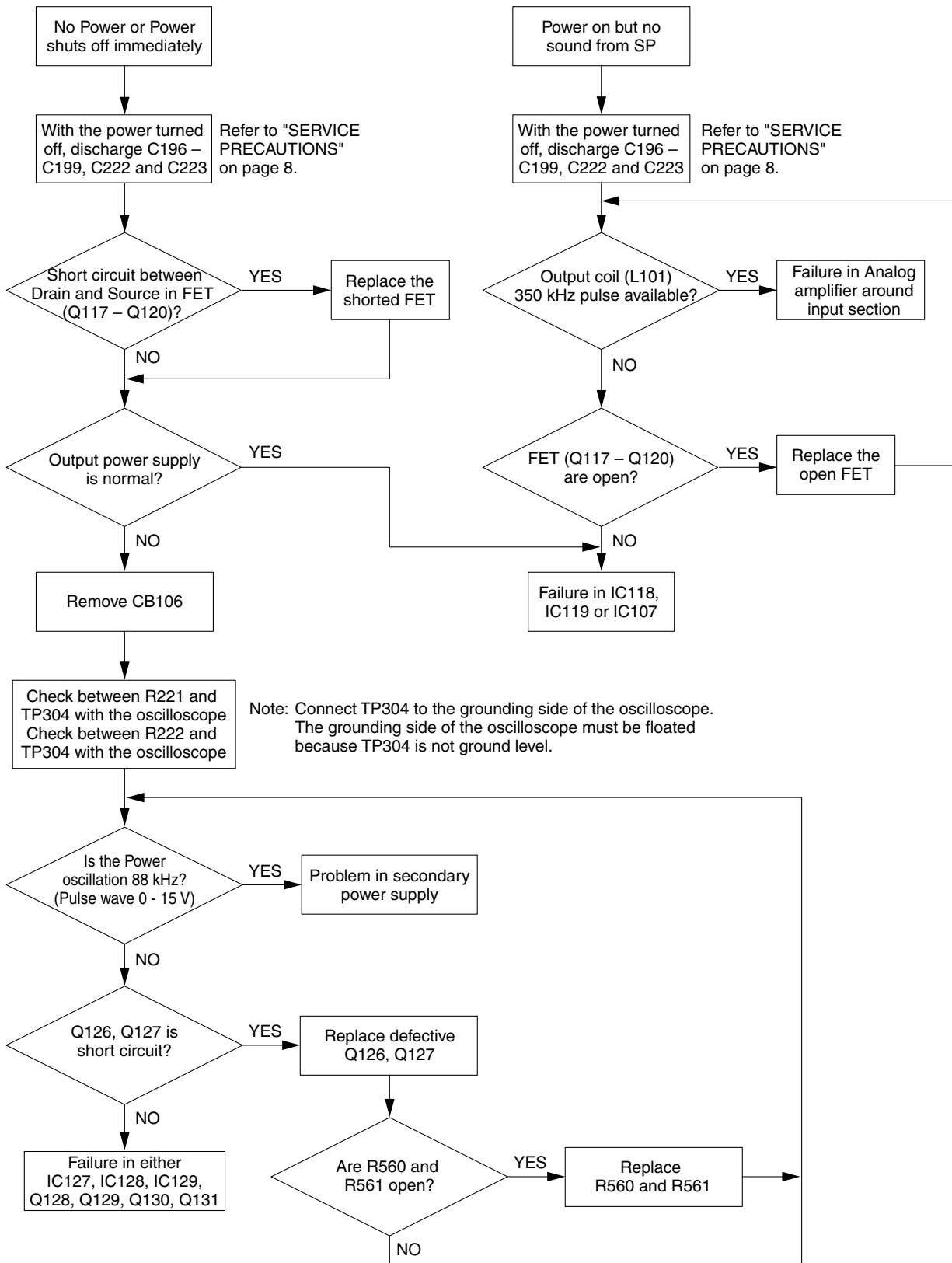
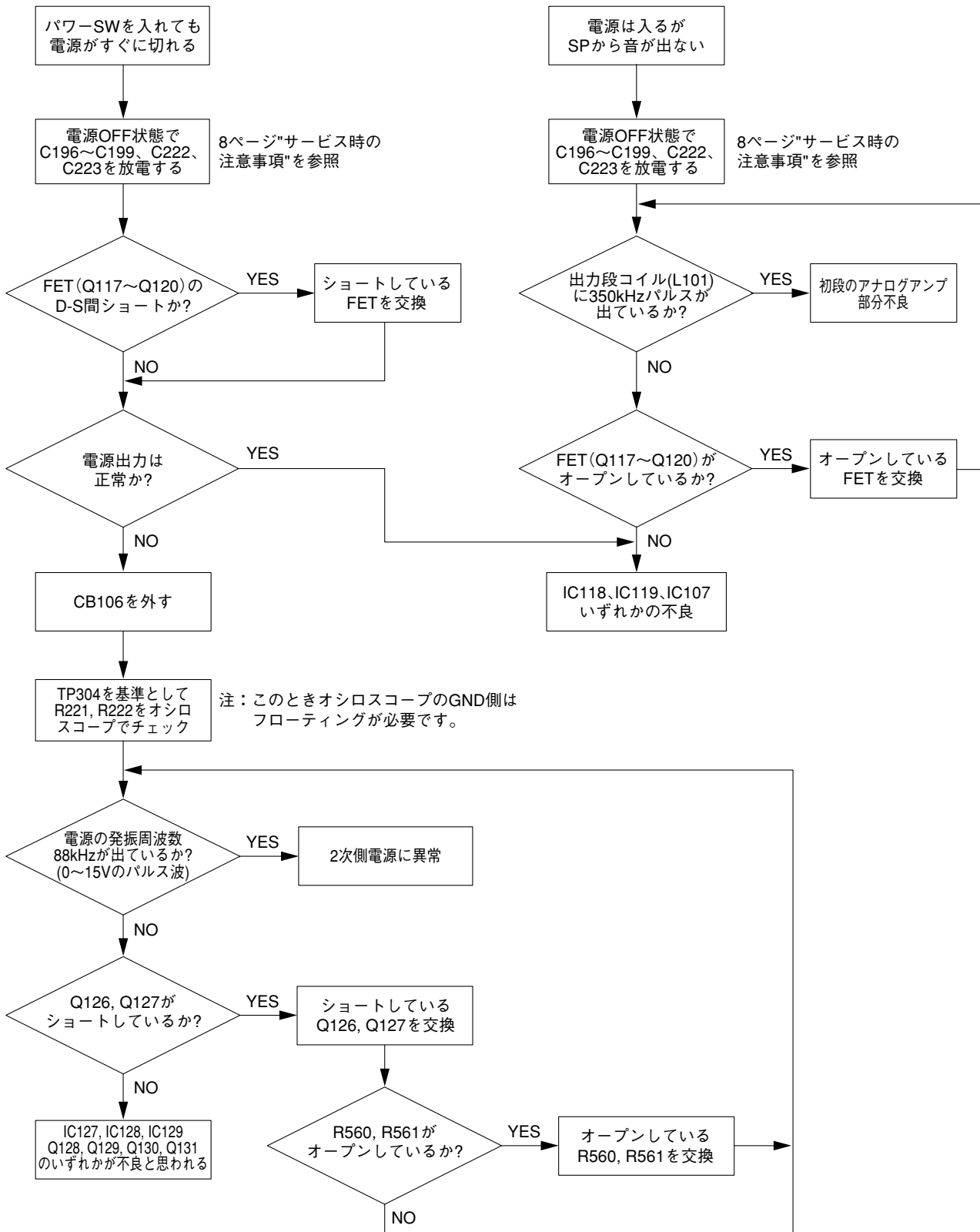

Fig. 9

■ TROUBLESHOOTING



■ 故障チェック方法



MX-D1

■ PROTECTION INFORMATION / プロテクション情報

It is possible to have the protection information displayed on a PC connected to this unit.

本機に接続したPC上にプロテクション情報を表示することができます。

Equipment required

- PC with RS-232C serial port
- Display application software (Terminal software such as hyper terminal supplied with WINDOWS)
- RS-232C cross cable "D-Sub 9-pin Female".

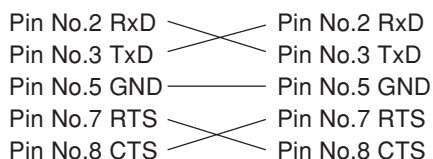

必要なツール

- RS-232Cシリアルポート付きPC
- 表示アプリケーション(WINDOWS付属のハイパーターミナル等のターミナルソフト)
- RS-232Cクロスケーブル"D-sub 9 pin メス"

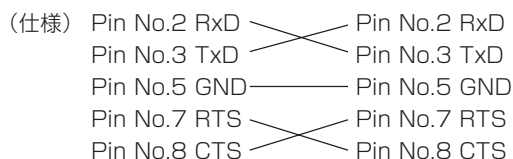

Operation

1. With the power turned off, connect the RS-232C cross cable to the PC and the RS-232C terminal of this unit.

操作

1. パワーオフ状態で、RS-232CクロスケーブルをPCと本機のRS-232C端子に接続します。

2. Turn on the power to the PC and make the terminal software settings as follows.

2. PCの電源をONし、ターミナルソフトを以下のように設定します。

Baud rate : 9600
Data : 8 bit
Parity : None
Stop bit : 1 bit
Flow control : Hardware flow

ボーレート : 9600
データ : 8ビット
パリティ : なし
ストップビット : 1ビット
フロー制御 : ハードフロー

3. Set the leftmost (closest to the RS-232C connector) DIP switch on the rear panel of the main unit to the ON position.

3. 本機リアパネルにあるDIPスイッチの一番左(RS-232Cコネクタに一番近いスイッチ)を"ON"にします。

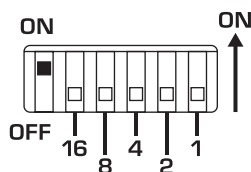

4. With the unit set in the standby state, press the "STANDBY/ON" key while pressing the "MUTE" key on the rear panel of the unit and keep pressing them for 3 seconds or longer.

4. スタンバイ状態で、本機リアパネルにある"MUTE"キーを押しながら"STANDBY/ON"キーを押し、両方を3秒間以上押し続けます。

5. The protection information as shown below is displayed on the PC screen.

Protection = PS PROTECTION R (or L)
: In case of PS protection
Protection = DC PS PROTECTION R (or L)
: In case of DC protection
Protection = I PROTECTION R (or L)
: In case of I protection
Protection = TEMP PROTECTION R (or L)
: In case of THERMAL protection
Protection = ICOUT PROTECTION R (or L)
: In case of ICOUT ERROR
Protection = NO PROTECTION
: In case of NO PROTECTION

Note: Any information on display other than the above has nothing to do with the protection information.

Erasing protection information

After the repair work is completed, erase the protection information according to the following procedures.

1. With the unit set in the standby state, press the "STANDBY/ON" key while pressing the "MUTE" key on the rear panel of the unit and then release the "MUTE" key but keep pressing the "STANDBY/ON" key only for 3 seconds or longer.
The blue LED flashes.
2. Press the "STANDBY/ON" key.
The red LED flashes.
3. Press the "STANDBY/ON" key.
The purple LED flashes.
4. Press the "STANDBY/ON" key.
The purple LED lights up.
5. Press the "STANDBY/ON" key.
The power is turned off and the protection information is erased at this time.

5. パソコン上に以下のようなプロテクション情報が表示されま
す。

Protection = PS PROTECTION R (or L)
: PSプロテクションの場合
Protection = DC PS PROTECTION R (or L)
: DCプロテクションの場合
Protection = I PROTECTION R (or L)
: Iプロテクションの場合
Protection = TEMP PROTECTION R (or L)
: 温度プロテクションの場合
Protection = ICOUT PROTECTION R (or L)
: ICOUTエラー検出の場合
Protection = NO PROTECTION
: プロテクション未検出の場合

注: 上記以外の表示はプロテクション情報とは関係ありません。

プロテクション情報の消去

修理後、下記の操作によりプロテクション情報を消去します。

1. スタンバイ状態で、本機リアパネルにある "MUTE" キーを押し
ながら "STANDBY/ON" キーを押した後、"MUTE" キーから
指を離し "STANDBY/ON" キーのみを3秒間以上押し続けま
す。
青色LEDが点滅します。
2. "STANDBY/ON" キーを押します。
赤色LEDが点滅します。
3. "STANDBY/ON" キーを押します。
紫色LEDが点滅します。
4. "STANDBY/ON" キーを押します。
紫色LEDが点灯します。
5. "STANDBY/ON" キーを押します。
電源が切れます。このときプロテクション情報が消去されま
す。

■ IC DATA

IC107: YDA133-E (MAIN P.C.B)
Digital Audio Power Amplifier Controller

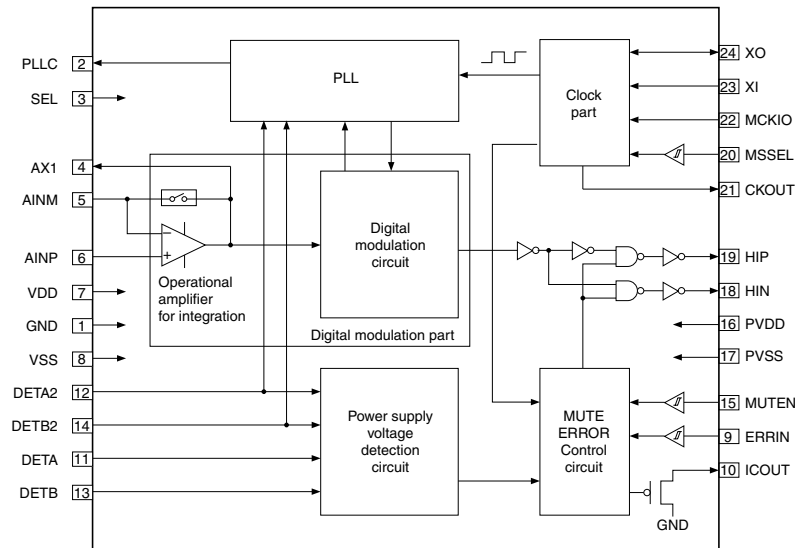

No.	Name	I/O	Function
1	GND		Ground
2	PLLC	AO	Connecting Loop Filter for Internal PLL
3	SEL	I	Test
4	AX1	AO	Precision Input Stage Operational Amplifier Output
5	AINM	AI	Precision Input Stage Operational Amplifier Inversion Input
6	AINP	AI	Precision Input Stage Operational Amplifier Non-inversion Input
7	VDD		Input Stage Analog Circuit Positive Power Supply
8	VSS		Input Stage Analog Circuit Negative Power Supply
9	ERRIN	I	Error Recognition Signal Input
10	ICOUT	OD	Error Recognition Signal Output
11	DETA	AI	Setting Reference Voltage for VPP and VMM Voltage Detection
12	DETA2	AI	Setting Open Loop Gain of Digital Amplifier
13	DETB	AIO	Connecting Capacitor for Setting Power Supply Tuning on Wait Time
14	DETB2	AI	Setting Digital Amplifier Open Loop Gain
15	MUTEN	I	Setting Mute
16	PVDD		Positive Power Supply for Output Buffer
17	PVSS		Negative Power Supply for Output Buffer
18	HIN	O	Digital Modulation Signal Inversion Output
19	HIP	O	Digital Modulation Signal Non-inversion Output
20	MSSEL	I	Changing Mode between Master and Slave
21	CKOUT	O	Local Power Supply Driving Clock Output
22	MCKIO	IO	Clock Input/Output
23	XI	I	5.6 MHz CERALOCK *1) Connection Input
24	XO	O	5.6 MHz CERALOCK *1) Connection Output (Unconnected)

Note)

AO : Analog Output

AI : Analog Input

AIO : Analog Input/Output

OD : Open Drain Output

PVDD and VDD are shortcircuited on the board.

PVSS and VSS are shortcircuited on the board.

GND is grounded on the board.

*1) CERALOCK of subsequent explanation is the registered trademark of Murata Manufacturing Co., Ltd.

IC118, 119: YDA134-E (MAIN P.C.B)
Digital Audio Power Amplifier Driver

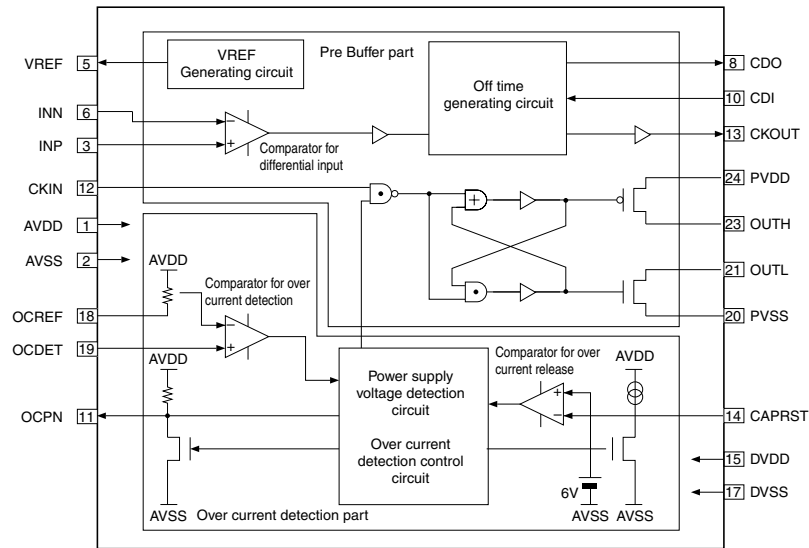

No.	Name	I/O	Function
1	AVDD		Positive Power Supply for Analog Circuits
2	AVSS		Connecting Reference Potential for Analog Circuits
3	INP	AI	Analog Signal Input (Positive Logic)
4	NC		– (Unconnected)
5	VREF	AO	Constant Voltage VREF Output
6	INN	AI	Analog Signal Input (Negative Logic)
7	NC		– (Unconnected)
8	CDO	O	Output Off Time Trigger Output
9	NC		– (Unconnected)
10	CDI	I	Output Off Time Trigger Input
11	OCPN	O	Over Current Detection Signal Output
12	CKIN	I	D-d synch. Signal Input
13	CKOUT	O	D-d synch. Signal Output
14	CAPRST	AIO	Connecting OCP Cancel Time Setting Capacitor
15	DVDD		Positive Power Supply for Digital Circuits
16	NC		– (Unconnected)
17	DVSS		Connecting Reference Potential for Digital Circuits
18	OCREF	AI	Connecting Reference Potential for Over Current Protection
19	OCDET	AI	Over Current Detection Input
20	PVSS		Connecting Reference Potential for Power MOSFET Drive Output
21	OUTL	O	Power MOSFET Drive Pull-down Output
22	NC		– (Unconnected)
23	OUTH	O	Power MOSFET Drive Pull-up Output
24	PVDD		Positive Power Supply for Power MOSFET Drive Output

Note)

- AO : Analog Output
- AI : Analog Input
- AIO: Analog Input/Output
- PVDD, AVDD and DVDD are shortcircuited on the board.
- PVSS, AVSS and DVSS are shortcircuited on the board.

IC701: M30624FGAFP (OPERATION P.C.B)
16 bit μ -COM

Pin	Pin function	Function	Name	Detail of function	I/O
1	P96/ANEX1/SOUT4	SOUT4		(Unconnected)	O
2	P95/ANEX0/CLK4	CLK4		(Unconnected)	SCK
3	P94/DA1/TB4in	DA1	FAN	Fan?	DA
4	P93/DA0/TB3in	P93		(Unconnected)	O
5	P92/TB2in/SOUT3	P92	VER2	Version Detect 2	SO
6	P91/TB1in/SIN3	P91	VER1	Version Detect 1	SI
7	P90/TB0in/CLK3	P90	VER0	Version Detect 0	SCK
8	BYTE	BYTE	BYTE	Single Chip: Vss	Vss
9	CNVss	CNVss	CNVss	When in Memory Expansion Mode: Vss	Vss/Vcc
10	P87/Xcin	P87	BKY	Boot Mode Key	I
11	P86/Xcout	P86		(Unconnected)	I
12	RESET	RESET	RESET	Reset	I
13	Xout	Xout	Xout	Oscillator Out	OPEN
14	Vss	Vss	Vss	CPU Ground	Vss
15	Xin	Xin	Xin	Oscillator In	12MHz
16	Vcc	Vcc	Vcc	+5V Power Supply for CPU	Vcc
17	P85/NMI	NMI	NMI	Not used	Vcc(PU)
18	P84/INT2	INT2	PSW	Power Switch	INT
19	P83/INT1	INT1	PDET	Power Detect	INT
20	P82/INT0	INT0	RXDR	232C Reception Data	INT (both edges)
21	P81/TA4in/U	P81		(Unconnected)	
22	P80/TA4out/U	TA4out	PCLK1	PS Power PWM1	O
23	P77/TA3in	P77		(Unconnected)	
24	P76/TA3out	TA3	MCLK	Digital Amp Master Clock	
25	P75/TA2in/W	P75	PSDR	Excess Current Detect R	
26	P74/TA2out/W	P74	PCLK2	PS Power PWM2	
27	P73/CTS/RTS2/TA1in/V	P73	PSDL	Excess Current Detect L	
28	P72/CLK2/TA1out/V	TA1out		(Unconnected)	O
29	P71/RXD2/SCL/TA0in/TB5in	P71		(Unconnected)	TBin5
30	P70/TXD2/SDA/TA0out	TA0out		(Unconnected)	O
31	P67/TXD1	TXD1	TXDF	FLASH PRG TXD	FLASH
32	P66/RXD1	RXD1	RXDF	FLASH PRG RXD	FLASH
33	P65/CLK1	CLK1	CLKF	FLASH PRG SYNC CLK	FLASH
34	P64/CTS1/RTS1/CTS0/CLKS1	P64	RTS/BSY	232C RTS Output	O/FALSH
35	P63/TXD0	TXD0	TXDR	232C Transmission Data	ASO
36	P62/RXD0	RXD0	RXDR	232C Reception Data	ASI
37	P61/CLK0	P61	RSPS	RS232C Power Control	O
38	P60/CTS0/RTS0	CTS0	CTS	232C CTS Input	I
39	P57/RDY/CLKout	P57		(Unconnected)	O
40	P56/ALE	P56		(Unconnected)	O
41	P55/HOLD	P55		(Unconnected)	GND
42	P54/HLDA	P54		(Unconnected)	O
43	P53/BCLK	P53		(Unconnected)	O
44	P52/RD	P52		(Unconnected)	O
45	P51/WRH/BHE	P51		(Unconnected)	I
46	P50/WRL/WR	P50		(Unconnected)	I
47	P47/CS3	P47		(Unconnected)	SO
48	P46/CS2	P46		(Unconnected)	SI
49	P45/CS1	P45		(Unconnected)	SCK
50	P44/CS0	P44		(Unconnected)	O

IC701: M30624FGAFP (OPERATION P.C.B)
16 bit μ -COM

Pin	Pin function	Function	Name	Detail of function	I/O
51	P43/A19	P43		(Unconnected)	
52	P42/A18	P42	LED2	LED 2 Standby	O
53	P41/A17	P41	LED1	LED 1 Protection	I
54	P40/A16	P40	LED0	LED 0 Power	I
55	P37/A15	P37	SPRR	Speaker Relay Rch	O
56	P36/A14	P36	SPRL	Speaker Relay Lch	O
57	P35/A13	P35	TRGIN	DC Trigger Input	O
58	P34/A12	P34	TRGSEL	DC Trigger Select : Through/Power	I (PU)
59	P33/A11	P33	TRGOUT	DC Trigger Output	O
60	P32/A10	P32	TISW	Trigger In Switch	I
61	P31/A9	P31		(Unconnected)	
62	Vcc	Vcc	Vcc	+5V Power Supply for CPU	Vcc
63	P30/A8	P30	PJSW	Pin Jack Switch	
64	Vss	Vss	Vss	CPU Ground	Vss
65	P27/A7	P27		(Unconnected)	
66	P26/A6	P26		(Unconnected)	
67	P25/A5	P25		(Unconnected)	
68	P24/A4	P24		(Unconnected)	
69	P23/A3	P23		(Unconnected)	
70	P22/A2	P22		(Unconnected)	
71	P21/A1	P21	DCRES	DC Reset	
72	P20/A0	P20	MT	Mute	O
73	P17/D15/INT5	INT5	TRGIN	DC Trigger Input	INT (both edges)
74	P16/D14/INT4	INT4		(Unconnected)	INT (LO edge)
75	P15/D13/INT3	P15	DIP5	DIP Switch 5	INT (LO edge)
76	P14/D12	P14	DIP4	DIP Switch 4	O
77	P13/D11	P13	DIP3	DIP Switch 3	I
78	P12/D10	P12	DIP2	DIP Switch 2	O
79	P11/D9	P11	DIP1	DIP Switch 1	I
80	P10/D8	P10	DIP0	DIP Switch 0	O
81	P07/D7	P07	/PRIR	Chip Error Detect R	
82	P06/D6	P06	/PRIL	Chip Error Detect L	O
83	P05/D5	P05		(Unconnected)	
84	P04/D4	P04		(Unconnected)	
85	P03/D3	P03		(Unconnected)	
86	P02/D2	P02		(Unconnected)	
87	P01/D1	P01	INR	Inrush	I
88	P00/D0	P00	PRY	Power Relay	O
89	P107/AN7	AN7	PRPSR	Power Voltage Detect R	AD
90	P106/AN6	AN6	PRPSL	Power Voltage Detect L	AD
91	P105/AN5	AN5		(Unconnected)	AD
92	P104/AN4	AN4		(Unconnected)	AD
93	P103/AN3	AN3	THMR	Power Amplifier Temperature Detect Rch	AD
94	P102/AN2	AN2	THML	Power Amplifier Temperature Detect Lch	AD
95	P101/AN1	AN1	PRDR	DC Protection Rch	AD
96	Avss	Avss	Avss	Ground for AD	Vss
97	P100/AN0	AN0	PRDL	DC Protection Lch	AD
98	Vref	Vref	Vref	Reference Voltage for AD	Vcc
99	Avcc	Avcc	Avcc	Power Supply for AD	Vcc
100	P97/Adtrg/Sin4	P97		(Unconnected)	I

■ BLOCK DIAGRAM (1/2)

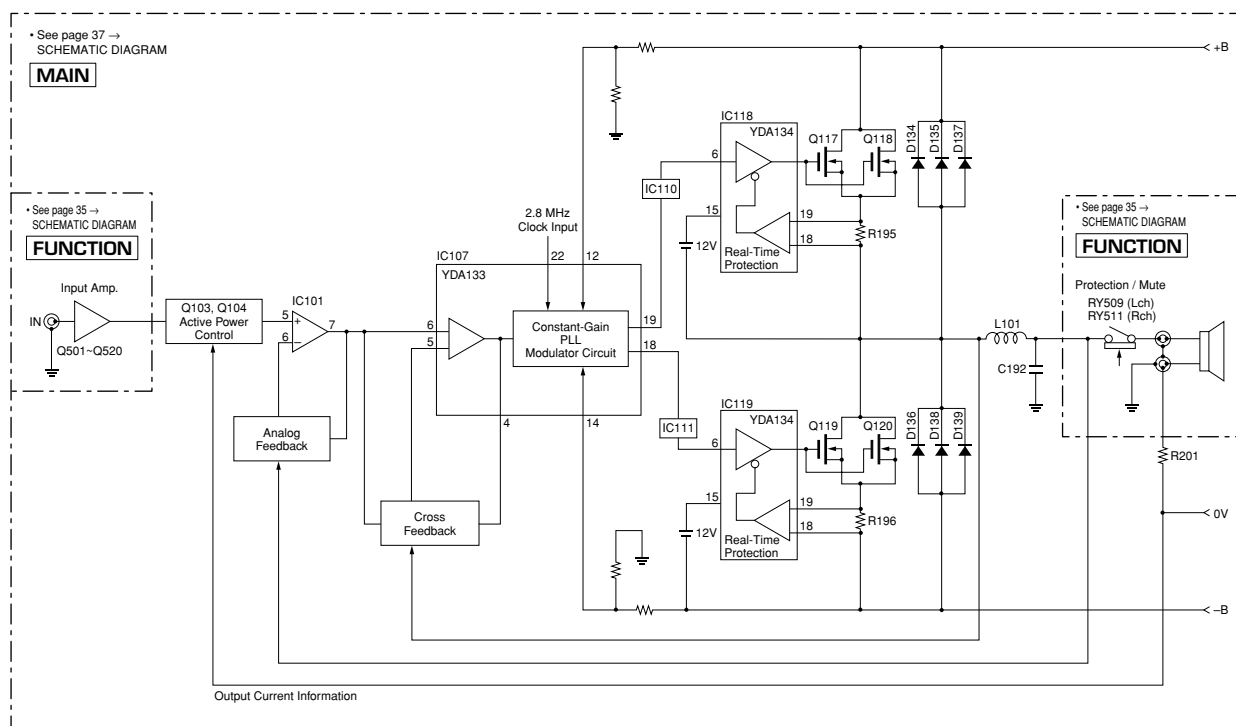

1 ■ BLOCK DIAGRAM (2/2)

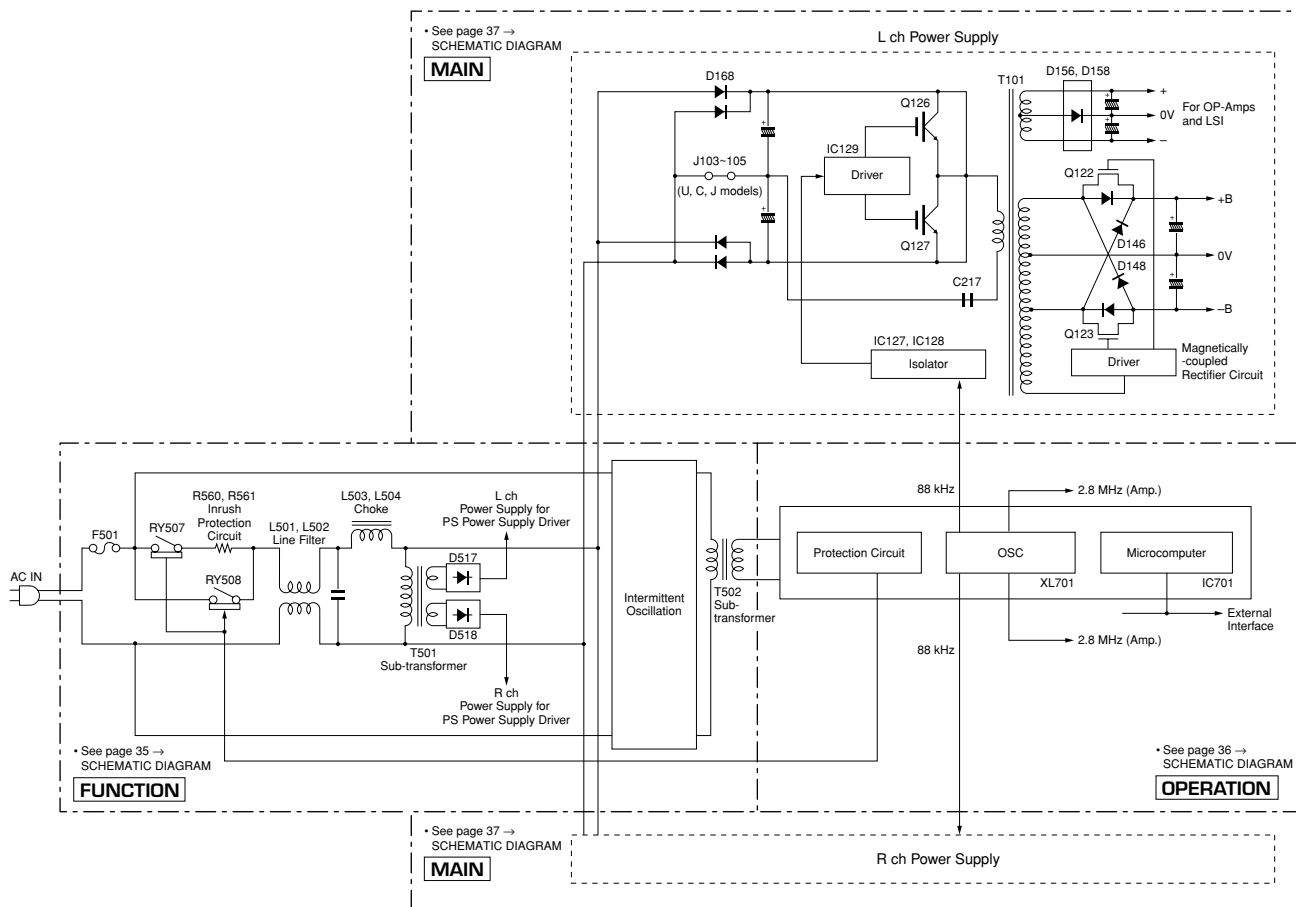

MX-D1

■ PRINTED CIRCUIT BOARD (Foil side)

FUNCTION (1) P. C. B. (Lead Type Device)

J model
U model (1st lot 50 sets only)

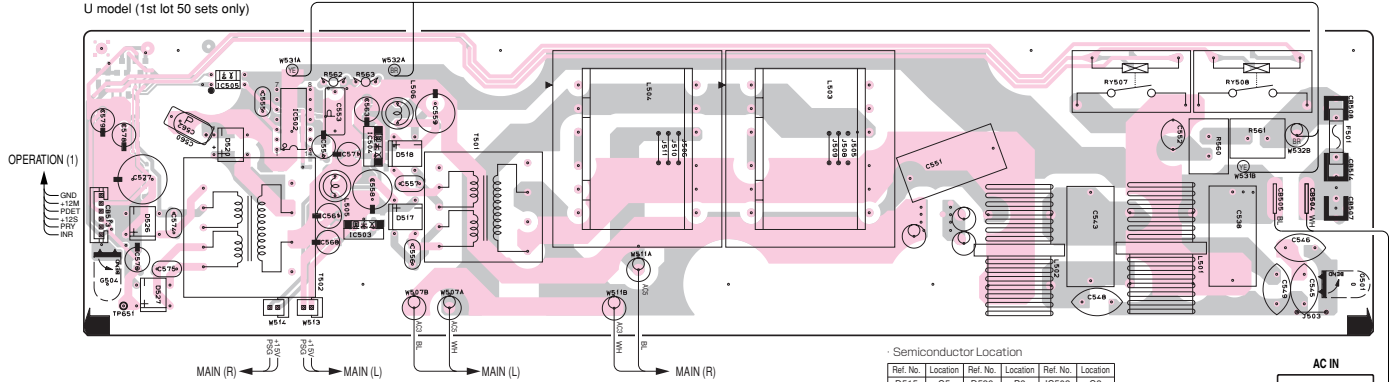

Semiconductor Location

Ref. No.	Location	Ref. No.	Location	Ref. No.	Location
D515	C5	D526	B3	IC502	C2
D516	C6	D527	B4	IC503	C3
D517	D3	D528	B6	IC504	C3
D518	D3	D529	B6	IC505	B2
D519	C6	D530	I5	IC506	B5
D520	B3	D531	I5	CS25	C6
D521	C6	D532	B5	CS28	B5
D522	C6	D533	A5	CS29	B5
D525	C6	D534	B5		

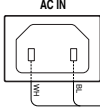

FUNCTION (1) P. C. B. (Surface Mount Device)

J model
U model (1st lot 50 sets only)

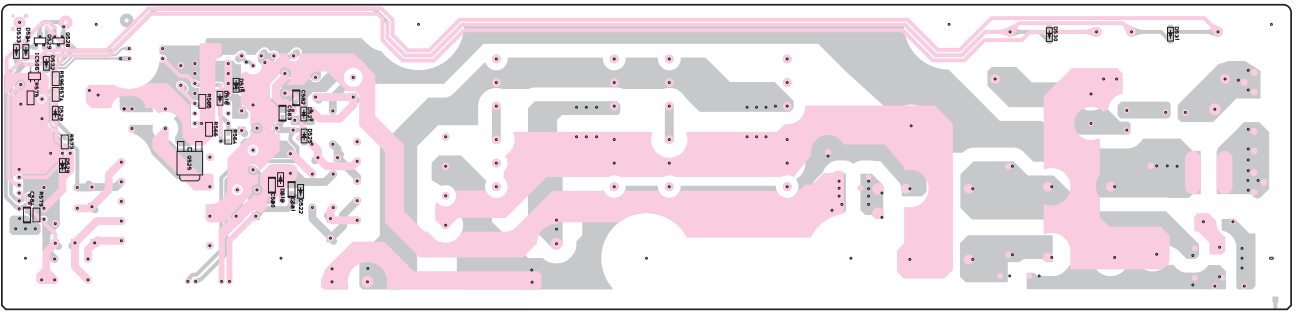

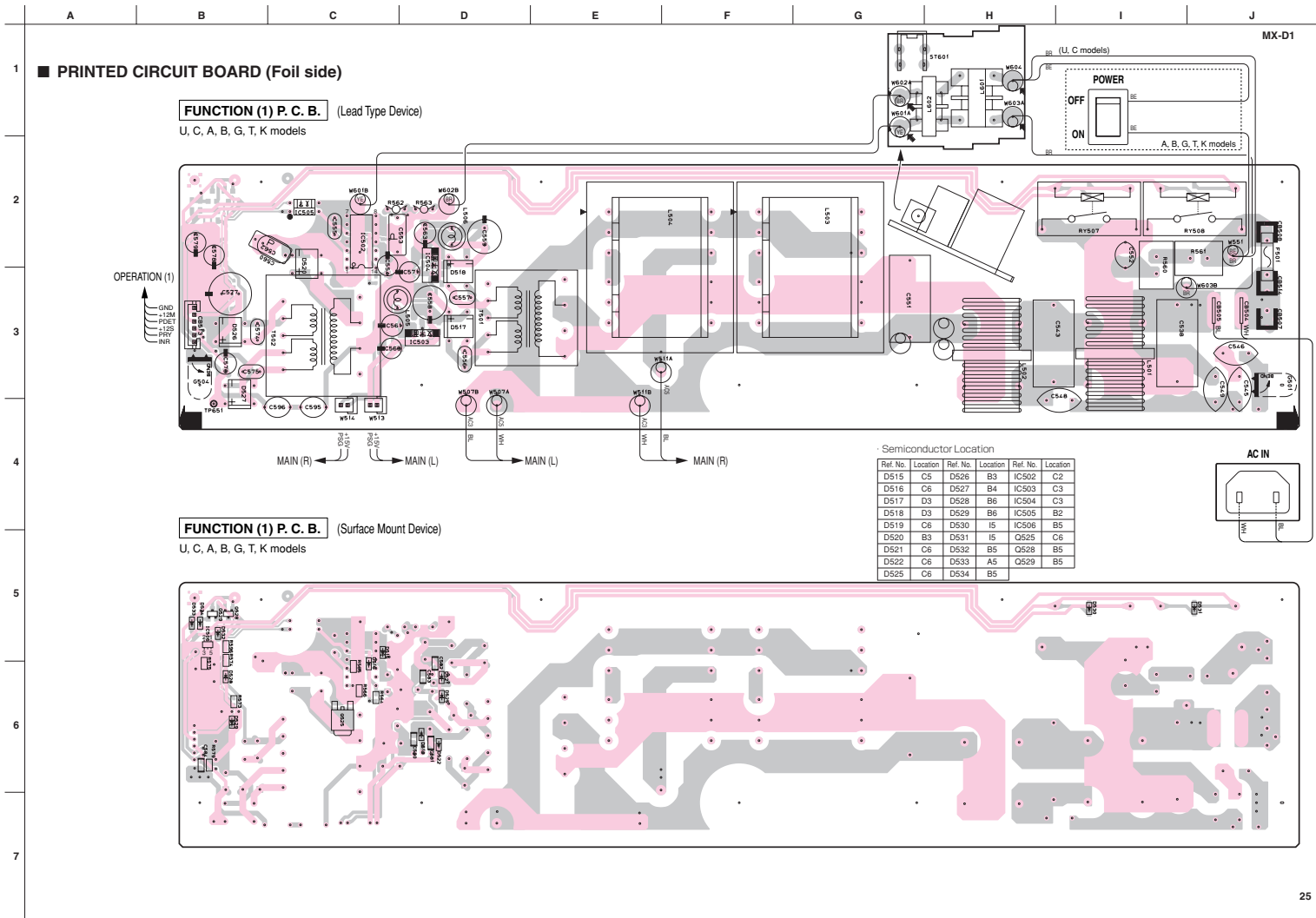

A B C D E F G H I J

MX-D1

■ PRINTED CIRCUIT BOARD (Foil side)

FUNCTION (7) P. C. B. (Lead Type Device)

FUNCTION (3) P. C. B. (Lead Type Device)

FUNCTION (6) P. C. B. (Lead Type Device)

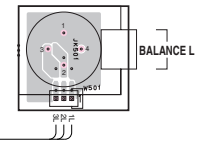
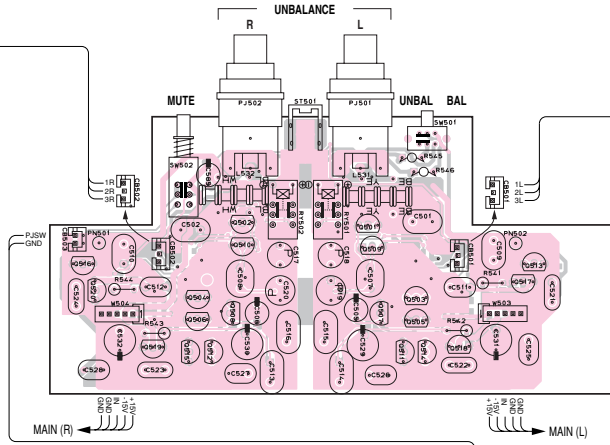
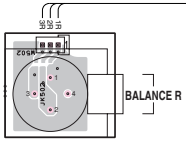

FUNCTION (4) P. C. B. (Lead Type Device)

FUNCTION (5) P. C. B. (Lead Type Device)

FUNCTION (2) P. C. B. (Lead Type Device)

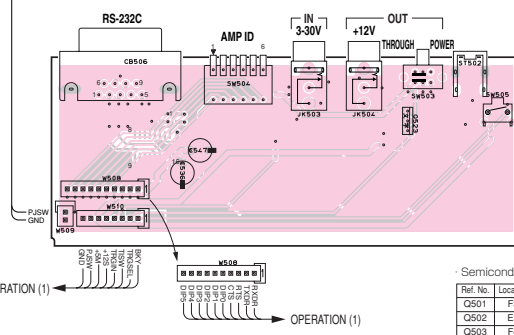
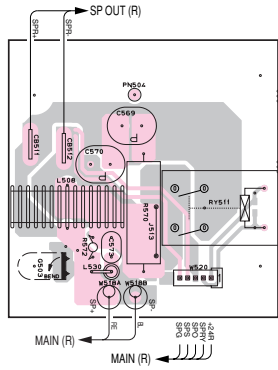
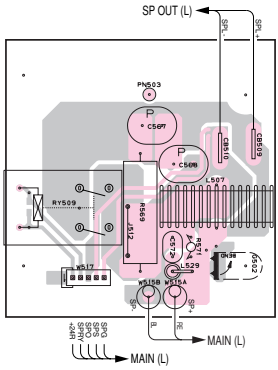

Semiconductor Location

Ref. No.	Location	Ref. No.	Location	Ref. No.	Location
Q501	F3	Q508	E4	Q515	D4
Q502	E3	Q509	F3	Q516	D3
Q503	F4	Q510	E3	Q517	G3
Q504	D4	Q511	F4	Q518	F4
Q505	F4	Q512	E4	Q519	D4
Q506	D4	Q513	G3	Q520	D3
Q507	F4	Q514	F4	Q523	I5

1 ■ PRINTED CIRCUIT BOARD (Foil side)

FUNCTION (7) P. C. B.
(Surface Mount Device)

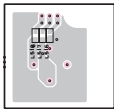

FUNCTION (3) P. C. B. (Surface Mount Device)

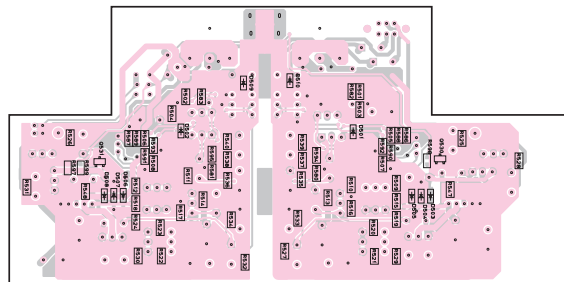

FUNCTION (6) P. C. B.
(Surface Mount Device)

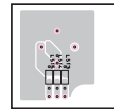

Circuit No.	U, C	J	A, B, G, T, K
C545, 546, 550, 562	X	X	O
C560	O	O	X
CB507	O	O	X
CB514	X	X	O
J503, 504	O	O	X
J505, 506, 508-511	X	O	X
L503, 504	O	X	O
W505, 506	X	X	O

X: NOT USED
O: USED / APPLICABLE

FUNCTION (4) P. C. B. (Surface Mount Device)

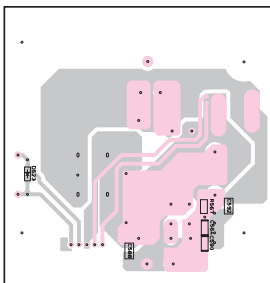

FUNCTION (5) P. C. B. (Surface Mount Device)

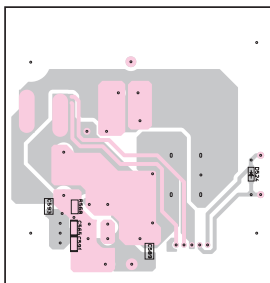

FUNCTION (2) P. C. B. (Surface Mount Device)

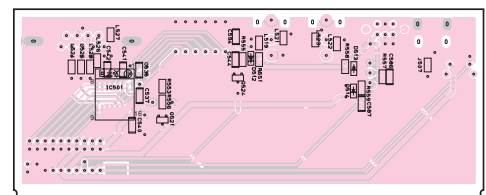

Semiconductor Location

Ref. No.	Location	Ref. No.	Location	Ref. No.	Location
D501	G3	D508	E4	D524	G5
D502	E3	D509	F3	IC501	G5
D503	G4	D510	F3	Q521	H6
D504	G4	D512	H5	Q524	H5
D505	G4	D513	I5	Q530	G3
D506	E4	D514	I5	Q531	E3
D507	E4	D523	B6		

1 ■ PRINTED CIRCUIT BOARD (Foil side)

OPERATION (1) P. C. B. (Surface Mount Device)

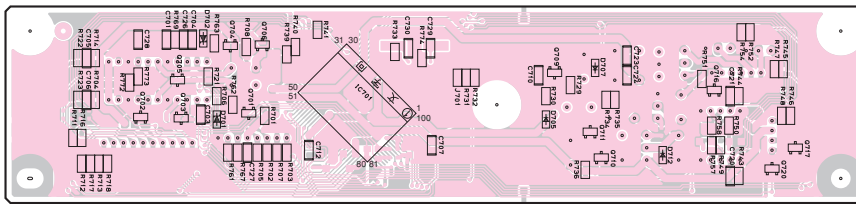

OPERATION (2) P. C. B. (Surface Mount Device)

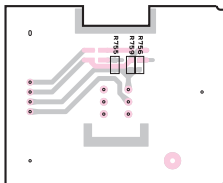

Circuit No.	U, C	J	A, B, G, T, K
J701	X	X	O

X: NOT USED
O: USED / APPLICABLE

Semiconductor Location

Ref. No.	Location	Ref. No.	Location	Ref. No.	Location
D701	C3	Q701	C3	Q709	E3
D702	C3	Q702	B3	Q710	F3
D705	E3	Q703	C3	Q711	E3
D707	E3	Q704	C3	Q716	F3
D712	F3	Q705	C3	Q717	G3
IC701	D3	Q706	C3	Q720	G3

PRINTED CIRCUIT BOARD (Foil side)

MAIN (R), MAIN (L) P. C. B. (Lead Type Device)

U, C, J models

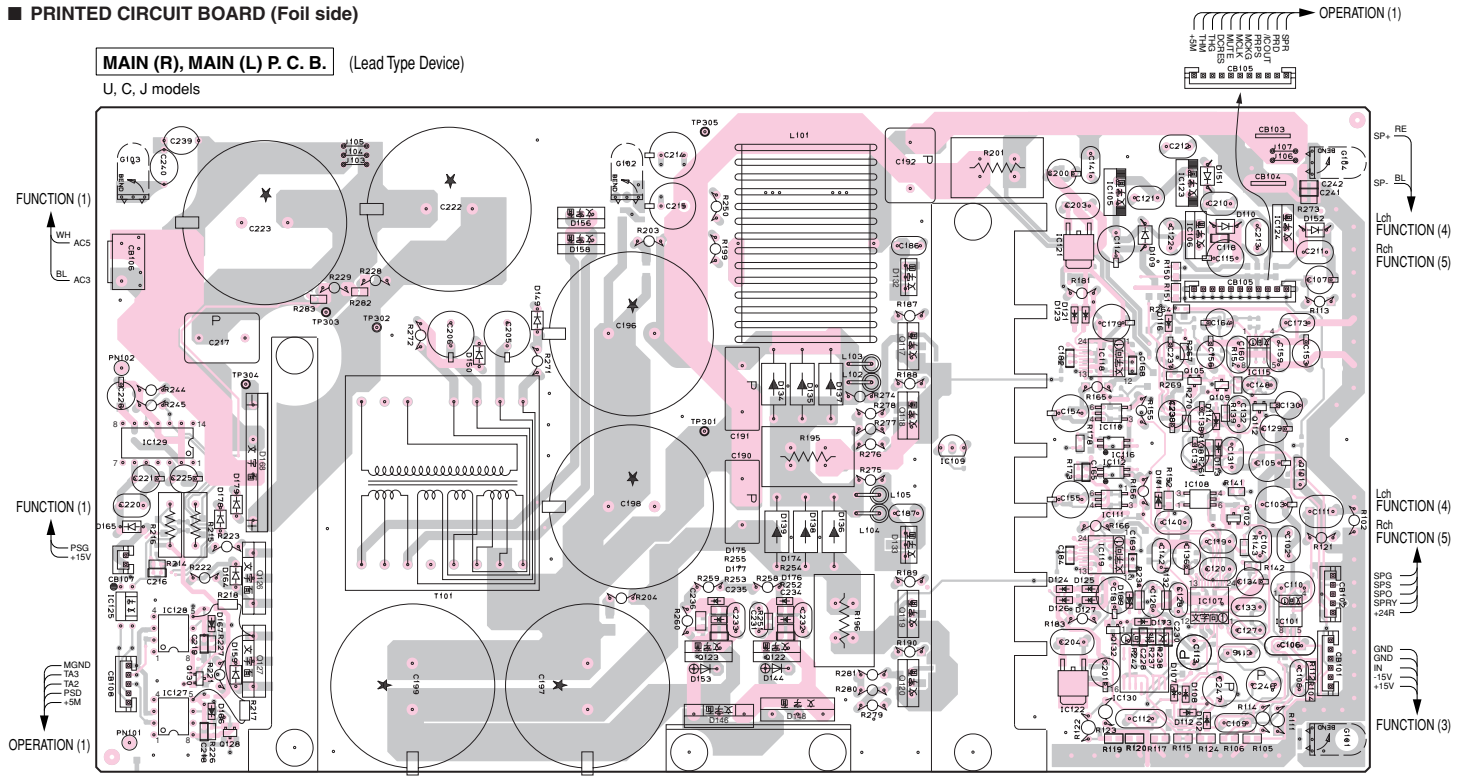

Semiconductor Location

Ref. No.	Location	Ref. No.	Location	Ref. No.	Location	Ref. No.	Location	Ref. No.	Location	Ref. No.	Location	Ref. No.	Location	Ref. No.	Location
D102	I5	D116	I3	D133	G5	D146	F6	D158	E3	D171	H4	IC101	I5	IC112	H4
D107	I5	D121	H3	D134	F3	D148	F6	D159	B5	D173	H5	IC105	H2	IC115	I3
D108	I5	D123	H3	D135	F3	D149	D3	D164	B5	D174	F5	IC106	I2	IC116	H4
D109	H2	D124	H5	D136	F4	D150	D3	D165	B4	D175	F5	IC107	I5	IC118	H3
D110	I2	D125	H5	D137	F3	D151	I2	D166	B6	D176	F5	IC108	I4	IC119	H5
D112	I5	D126	H5	D138	F4	D152	J2	D167	B5	D177	F5	IC109	G4	IC121	H3
D113	I4	D127	H5	D139	F4	D153	E5	D168	C4	D178	B4	IC110	H4	IC122	H5
D114	I4	D132	G3	D144	F5	D156	E2	D169	H5	D179	B4	IC111	H4	IC123	I2
														Q102	I4
														Q122	F5

The MAIN P.C.B. consists of 4 layer patterns (part surface pattern, inner layer No.1 pattern, inner layer No.2 pattern, solder surface pattern) but this drawing shows only the part surface pattern and solder surface pattern.

MAIN P.C.B.は4層パターン構造(部品面パターン、内装1パターン、内装2パターン、ハンダ面パターン)ですが、本図のパターンは、部品面パターンとハンダ面パターンのみ表記しています。

1 ■ PRINTED CIRCUIT BOARD (Foil side)

MAIN (R), MAIN (L) P. C. B. (Surface Mount Device)

U, C, J models

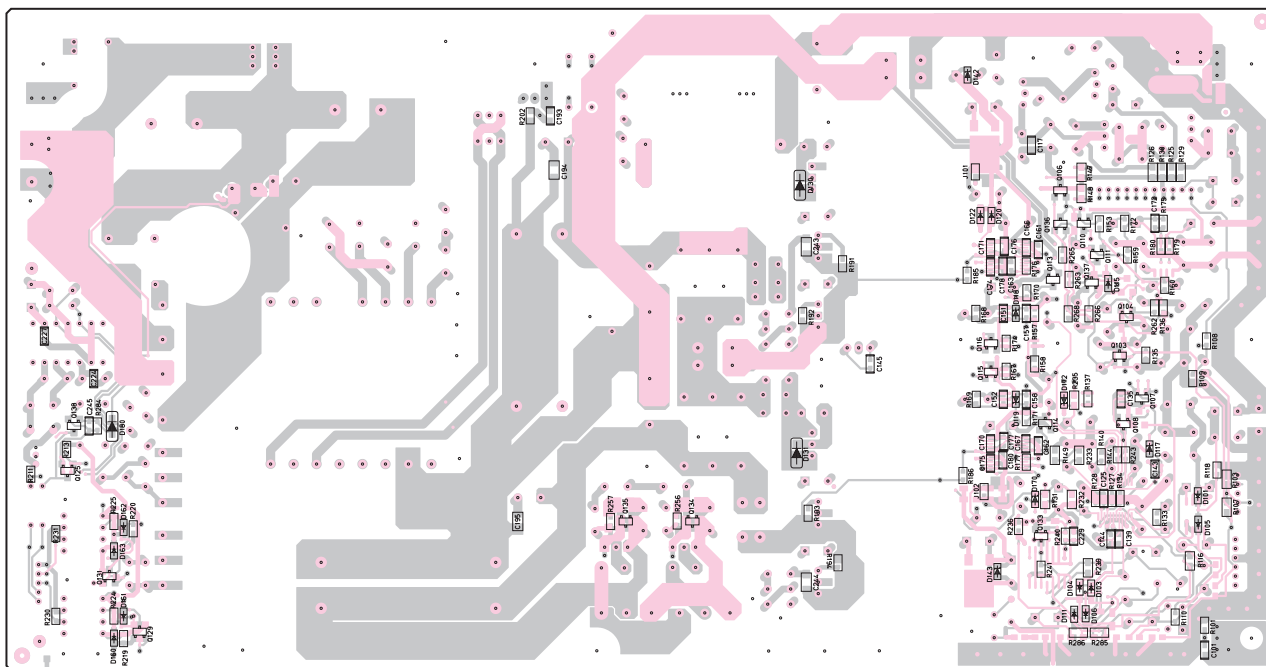

The MAIN P.C.B. consists of 4 layer patterns (part surface pattern, inner layer No.1 pattern, inner layer No.2 pattern, solder surface pattern) but this drawing shows only the part surface pattern and solder surface pattern.

MAIN P.C.B.は4層パターン構造(部品面パターン、内装1パターン、内装2パターン、ハンダ面パターン)ですが、本図のパターンは、部品面パターンとハンダ面パターンのみ表記しています。

・ Semiconductor Location

Ref. No.	Location	Ref. No.	Location	Ref. No.	Location	Ref. No.	Location	Ref. No.	Location	Ref. No.	Location	Ref. No.	Location
D101	J5	D111	I5	D120	H5	D143	H5	D170	I5	Q106	I3	Q113	I3
D103	I5	D115	I3	D122	H3	D160	B6	D172	I4	Q107	I4	Q114	I4
D104	I5	D117	I5	D130	G3	D161	C6	D180	B4	Q108	I4	Q115	H4
D105	J5	D118	H4	D131	G5	D162	C5	Q103	I4	Q110	I3	Q116	H4
D106	I5	D119	H4	D142	H2	D163	B5	Q104	I4	Q111	I3	Q125	B5
												Q133	I5
												Q134	F5
												Q135	F5
												Q138	B4
												Q139	I3
												Q137	I3

1 ■ PRINTED CIRCUIT BOARD (Foil side)

MAIN (R), MAIN (L) P. C. B. (Surface Mount Device)

A, B, G, T, K, models

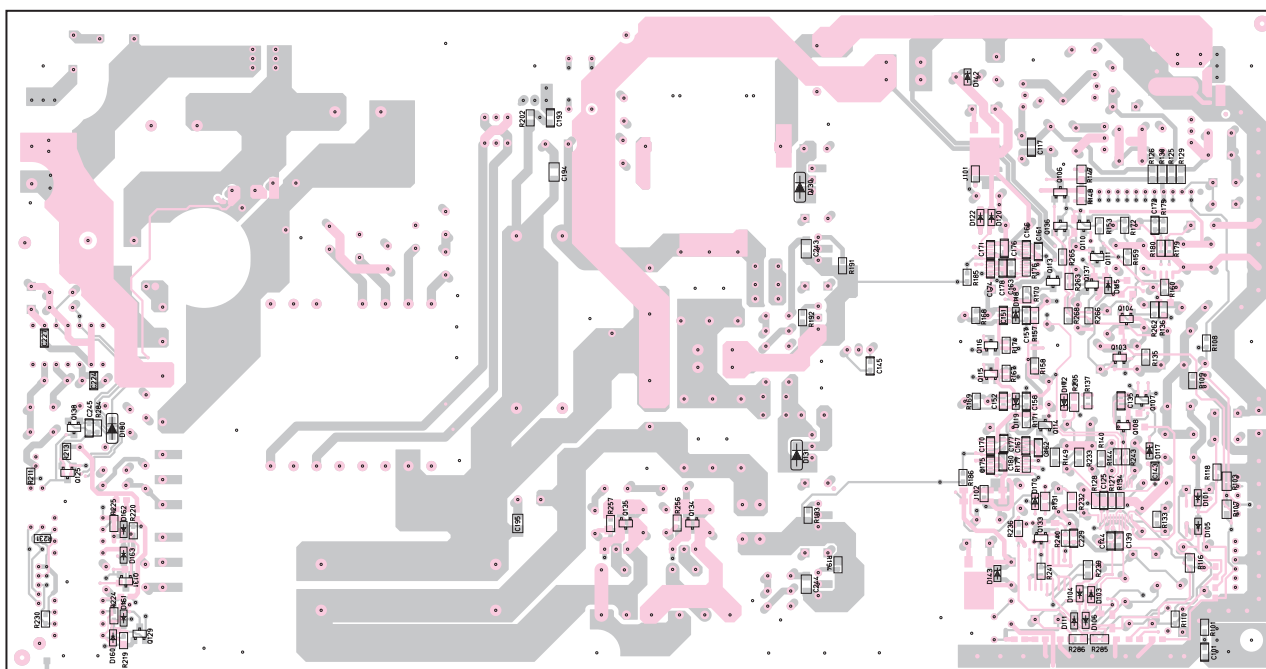

The MAIN P.C.B. consists of 4 layer patterns (part surface pattern, inner layer No.1 pattern, inner layer No.2 pattern, solder surface pattern) but this drawing shows only the part surface pattern and solder surface pattern.

MAIN P.C.B.は4層パターン構造(部品面パターン、内装1パターン、内装2パターン、ハンダ面パターン)ですが、本図のパターンは、部品面パターンとハンダ面パターンのみ表記しています。

・ Semiconductor Location

Ref. No.	Location	Ref. No.	Location	Ref. No.	Location	Ref. No.	Location	Ref. No.	Location	Ref. No.	Location	Ref. No.	Location
D101	J5	D111	I5	D120	H5	D143	H5	D170	I5	Q106	I3	Q113	I3
D103	I5	D115	I3	D122	H3	D160	B6	D172	I4	Q107	I4	Q114	I4
D104	I5	D117	I5	D130	G3	D161	C6	D180	B4	Q108	I4	Q115	H4
D105	J5	D118	H4	D131	G5	D162	C5	Q103	I4	Q110	I3	Q116	H4
D106	I5	D119	H4	D142	H2	D163	B5	Q104	I4	Q111	I3	Q125	B5
												Q133	F5
												Q138	B4

MX-D1

■ PIN CONNECTION DIAGRAM

• ICs

<p>AN78L12</p>	<p>LM61CIZ</p>	<p>NJU7201L55</p>	<p>NJM78M05FA</p>	<p>NJM78M15FA</p>
<p>NJM79M05FA NJM79M15FA</p>	<p>AN7712SP-E1</p>	<p>BD4825G-TR</p>	<p>NJM072M</p>	<p>IR2110</p>
<p>TC4013BP</p>	<p>ADM202JRN-REEL7</p>	<p>TC4053BF</p>	<p>YDA133-E YDA134-E</p>	<p>M30624FGAFP</p>

• Diodes

<p>11EQS04 AG01A DTNL20U EL1LF-HSK RL3LF014-302</p>	<p>1SS355 1SS380 MA8027-L MA8043-M MA8047-M MA8051-M MA8092-L MA8075-M MA8100-M MA8130-M MA8160-H RLZ36.0B</p>		
<p>FMU-12R FMU-36R</p>	<p>FMU-12S FMU-36S SF20SC4</p>	<p>S1NB20 S1NB60</p>	<p>LN25XB60</p>

• Transistors

<p>2SA1015 2SC1815</p>	<p>2SC4391</p>	<p>1MBK50D</p>	<p>2SA1708</p>	<p>2SA1037K 2SC2412K 2SU1938F DTA114EKA DTA144EKA DTC114EKA DTC144EKA</p>
<p>2SK369</p>	<p>2SK2965 2SK3342 2SK3373</p>	<p>2SK2823</p>	<p>STP20NM50</p>	<p>STP20NM50FP</p>

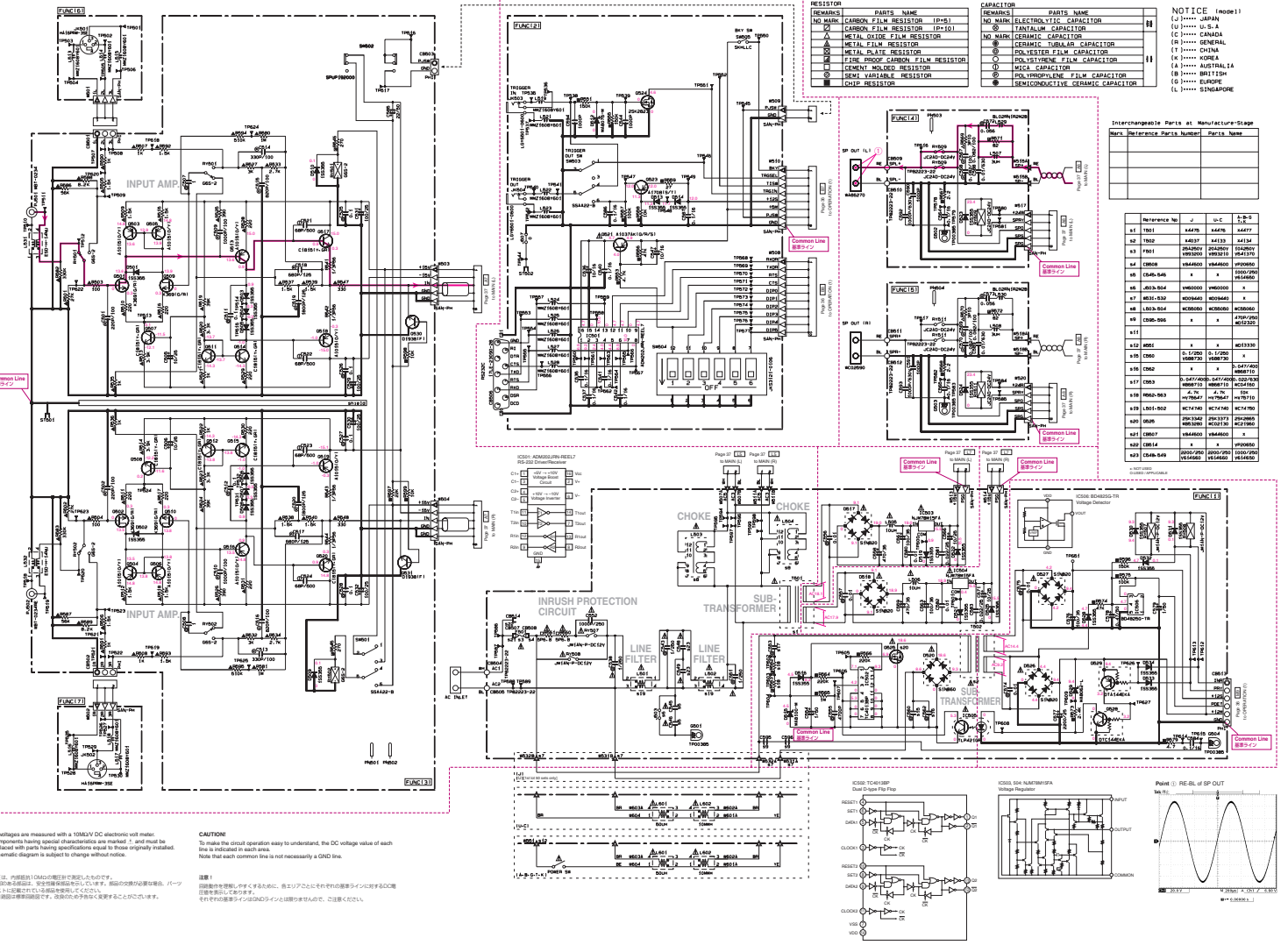

RESISTOR

REMARKS	PARTS NAME
NO MARK	CARBON FILM RESISTOR (FMS)
△	CARBON FILM RESISTOR (F-10)
▲	METAL OXIDE FILM RESISTOR
△	METAL FILM RESISTOR
□	FILM PROOF CARBON FILM RESISTOR
■	CEMENT MOUNTED RESISTOR
○	SEMI-CONDUCTIVE RESISTOR
◎	CHIP RESISTOR

CAPACITOR

REMARKS	PARTS NAME
NO MARK	ELECTROLYTIC CAPACITOR
○	TANTALUM CAPACITOR
NO MARK	CERAMIC CAPACITOR
□	CERAMIC TUBULAR CAPACITOR
◎	POLYESTER FILM CAPACITOR
○	POLYSTYRENE FILM CAPACITOR
○	MICA CAPACITOR
○	ION-EXCHANGE FILM CAPACITOR
◎	SEMICONDUCTIVE CERAMIC CAPACITOR

NOTICE (page 1)

(J)..... JAPAN
 (U)..... U.S.A.
 (C)..... CANADA
 (G)..... GENERAL
 (F)..... CHINA
 (K)..... KOREA
 (A)..... AUSTRALIA
 (B)..... BRITISH
 (E)..... EUROPE
 (L)..... SINGAPORE

Interchangeable Parts at Manufacture Stage

Part Reference	Part Number	Part Name

Reference No.	J	U	C	F	K	A	B	E	L
A1	TR1	44318	44318	44318	44318				
A2	TR2	44317	44317	44317	44317				
A3	FR1	28A200V	28A200V	28A200V	28A200V				
A4	CR108	18A480	18A480	18A480	18A480				
A5	CR109	18A480	18A480	18A480	18A480				
A6	CR110	18A480	18A480	18A480	18A480				
A7	CR111	18A480	18A480	18A480	18A480				
A8	CR112	18A480	18A480	18A480	18A480				
A9	CR113	18A480	18A480	18A480	18A480				
A10	CR114	18A480	18A480	18A480	18A480				
A11	CR115	18A480	18A480	18A480	18A480				
A12	CR116	18A480	18A480	18A480	18A480				
A13	CR117	18A480	18A480	18A480	18A480				
A14	CR118	18A480	18A480	18A480	18A480				
A15	CR119	18A480	18A480	18A480	18A480				
A16	CR120	18A480	18A480	18A480	18A480				
A17	CR121	18A480	18A480	18A480	18A480				
A18	CR122	18A480	18A480	18A480	18A480				
A19	CR123	18A480	18A480	18A480	18A480				
A20	CR124	18A480	18A480	18A480	18A480				
A21	CR125	18A480	18A480	18A480	18A480				
A22	CR126	18A480	18A480	18A480	18A480				
A23	CR127	18A480	18A480	18A480	18A480				
A24	CR128	18A480	18A480	18A480	18A480				
A25	CR129	18A480	18A480	18A480	18A480				
A26	CR130	18A480	18A480	18A480	18A480				

Capacitors are measured with a 105kV DC electronic cell meter. Components having special characteristics are marked * and must be dealt with with special handling instructions noted in those originally installed. Schematic diagram is subject to change without notice.

CAUTION
 To make the circuit operation easy to understand, the DC voltage value of each line is indicated in each area.
 Note that each common line is not necessarily a GND line.

コンデンサは105kV DC電子セルメータで測定します。特殊な特性を有する部品は*で示され、取り扱いに特別な注意が必要です。回路図は変更される場合があります。

注意
 回路動作を容易にするために、各ラインにその直流電圧値を示すDC電圧値を記載しています。
 なお、各共通ラインは必ずしも接地線とは限りません。

IC301 AD8254P (REV.07)
 IC302 74VHC00 (REV.07)

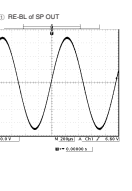
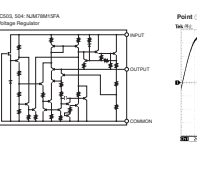
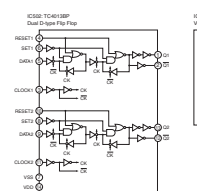
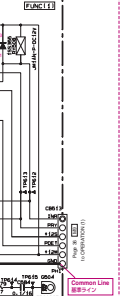
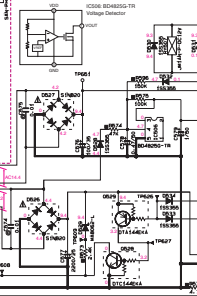
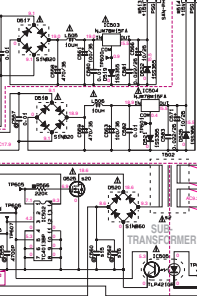
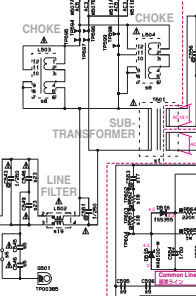
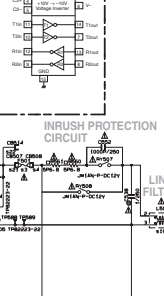

DIAGRAM (OPERATION)

- All voltages are measured with a 10MΩV DC electronic volt meter.
 - Components having special characteristics are marked * and must be replaced with parts having specifications equal to those originally installed.
 - Schematic diagram is subject to change without notice.
- 電圧は、内蔵抵抗10MΩの電圧計で測定したものです。
 * 特殊な特性を有する部品は、*印で表示されています。取換の際は必ず同等の部品を、パーツリストに記述されている規格値を参照してご使用ください。
 ● 回路図は仕様変更を伴って変更することがあります。

RESISTOR	REMARKS	PARTS NAME
□	NO MARK	CARBON FILM RESISTOR (P=5)
□	□	CARBON FILM RESISTOR (P=10)
△	△	METAL OXIDE FILM RESISTOR
◇	◇	METAL FILM RESISTOR
▢	▢	METAL PLATE RESISTOR
▣	▣	FIRE PROOF CARBON FILM RESISTOR
⊞	⊞	CEMENT MOLDED RESISTOR
⊕	⊕	SEMI-VARIABLE RESISTOR
⊖	⊖	TRIMP RESISTOR

CAPACITOR	REMARKS	PARTS NAME
⊗	NO MARK	ELECTROLYTIC CAPACITOR
⊙	⊙	TANTALUM CAPACITOR
⊚	⊚	NO MARK CERAMIC CAPACITOR
⊛	⊛	CERAMIC TUBULAR CAPACITOR
⊜	⊜	POLYESTER FILM CAPACITOR
⊝	⊝	POLYSTYRENE FILM CAPACITOR
⊞	⊞	MICA CAPACITOR
⊟	⊟	POLYPROPYLENE FILM CAPACITOR
⊠	⊠	SEMICONDUCTIVE CERAMIC CAPACITOR

Interchangeable Parts at Manufacture-Stage

Stock	Reference Parts Number	Parts Name
41	0701, 704, 706, 710, 714, 718	2IC24K10/P/S1 2000110/P/S1

Reference No.	J	U.S.	A-B-C	D
41	2701	x	x	200000

NOTICE (code11)

(J)..... JAPAN
 (U)..... U.S.A
 (C)..... CANADA
 (R)..... GENERAL
 (T)..... CHINA
 (K)..... KOREA
 (A)..... AUSTRALIA
 (B)..... BRITISH
 (G)..... EUROPE
 (L)..... SINGAPORE

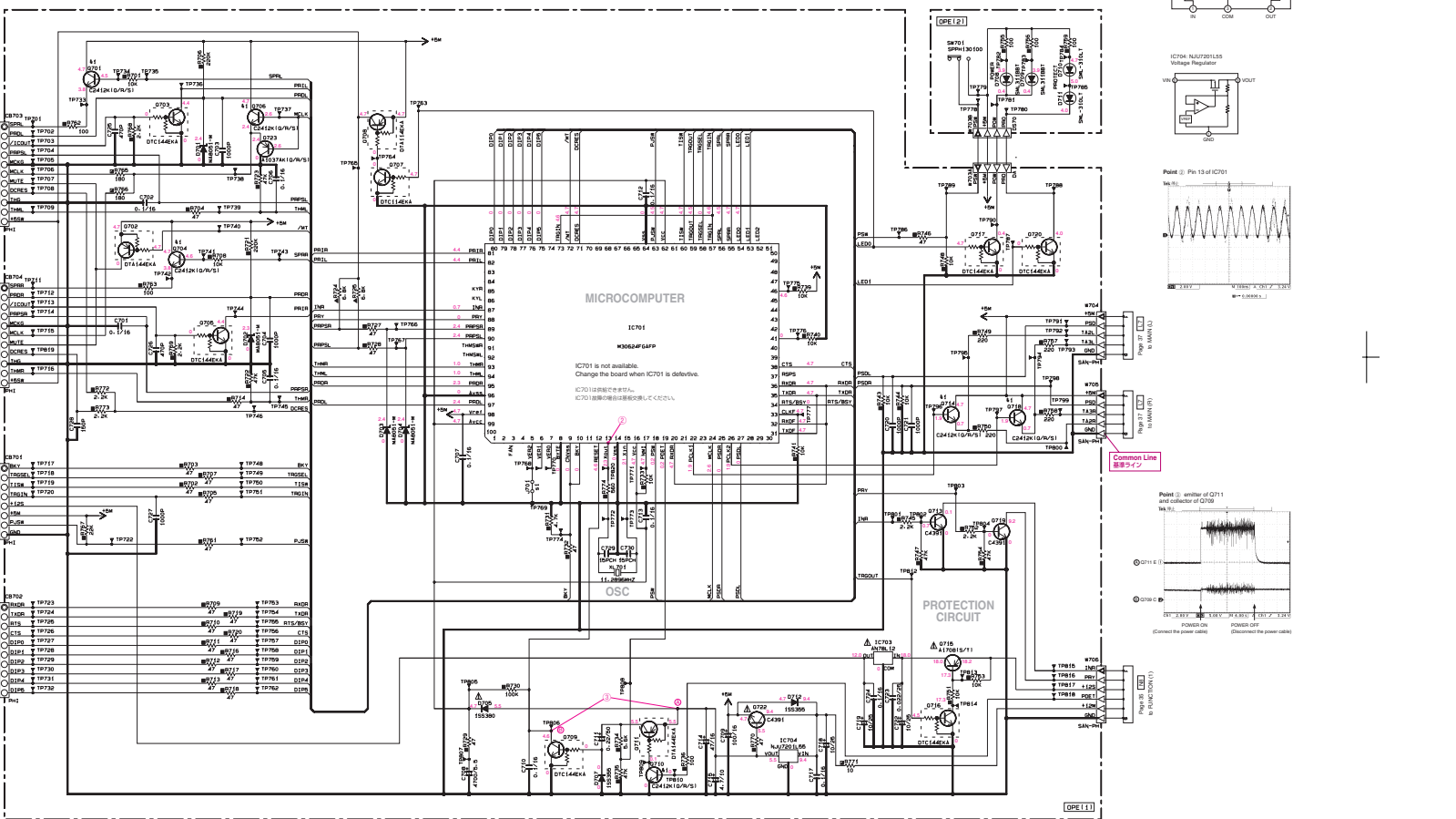
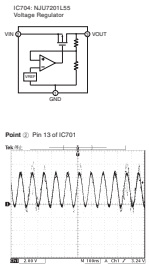
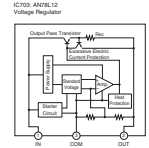

HEMATIC DIAGRAM (MAIN L, MAIN R)

MX-01

RESISTOR	PARTS NAME	RESISTOR	PARTS NAME
R1	10K OHM 1/4W	R10	10K OHM 1/4W
R2	10K OHM 1/4W	R11	10K OHM 1/4W
R3	10K OHM 1/4W	R12	10K OHM 1/4W
R4	10K OHM 1/4W	R13	10K OHM 1/4W
R5	10K OHM 1/4W	R14	10K OHM 1/4W
R6	10K OHM 1/4W	R15	10K OHM 1/4W
R7	10K OHM 1/4W	R16	10K OHM 1/4W
R8	10K OHM 1/4W	R17	10K OHM 1/4W
R9	10K OHM 1/4W	R18	10K OHM 1/4W

- All voltages are measured with a 1000V DC electronic volt meter.
- Components having special characteristics are marked Φ and must be replaced with parts having specifications equal to those originally installed.
- Schematic diagram is subject to change without notice.

CAUTION
To make the circuit operation easy to understand, the DC voltage value of each line is indicated in each area.
Note that each common line is not necessarily a GND line.

NOTICE

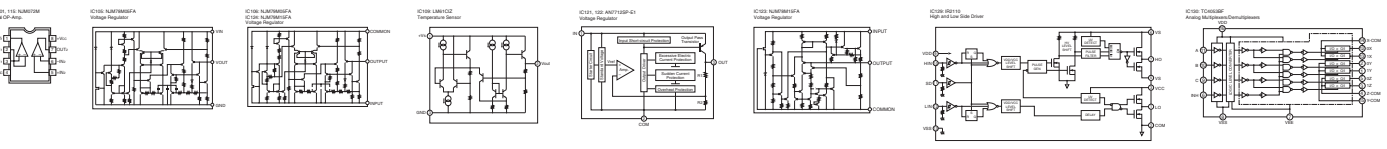
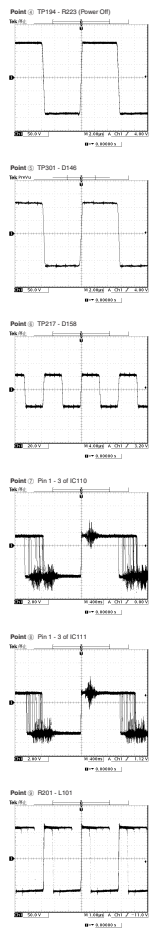
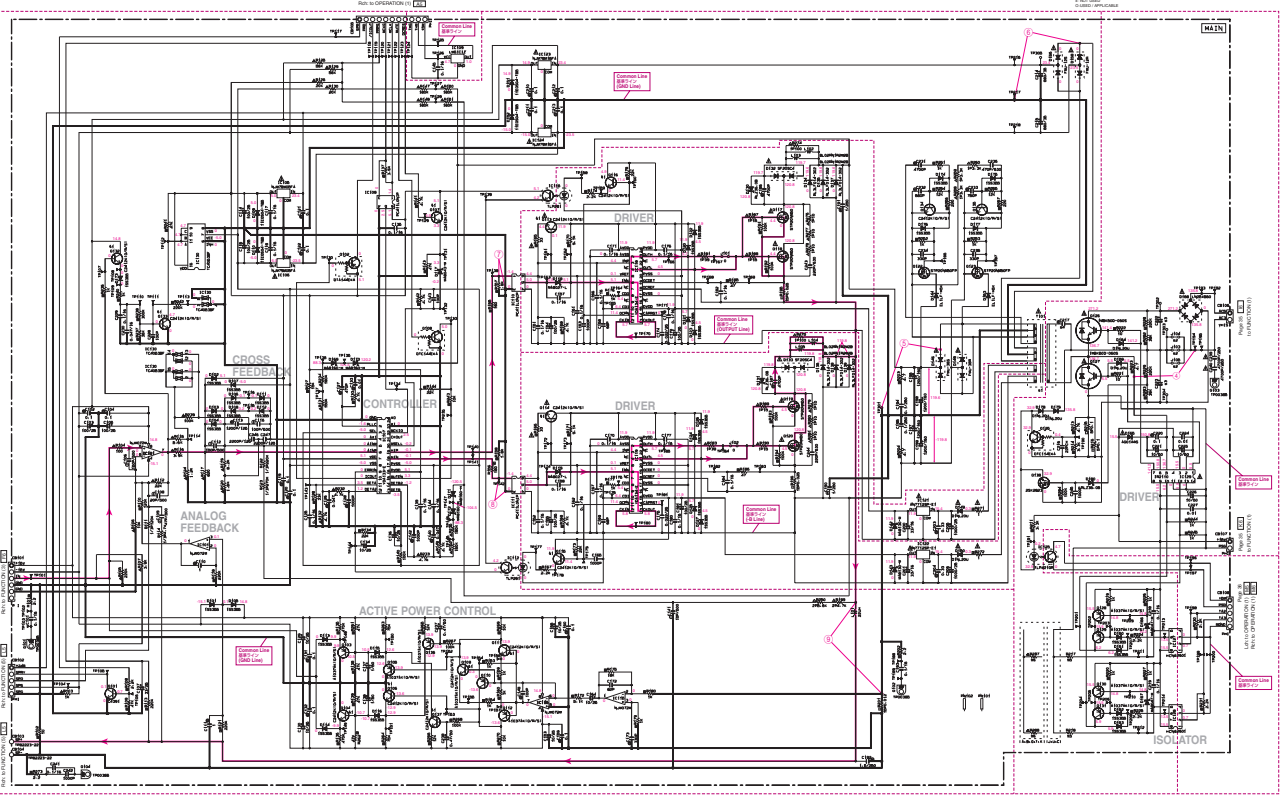

Reference No.	Part	QTY	UNIT
1	IC1	1	PCB
2	IC2	1	PCB
3	IC3	1	PCB
4	IC4	1	PCB
5	IC5	1	PCB
6	IC6	1	PCB
7	IC7	1	PCB
8	IC8	1	PCB
9	IC9	1	PCB
10	IC10	1	PCB
11	IC11	1	PCB
12	IC12	1	PCB
13	IC13	1	PCB
14	IC14	1	PCB
15	IC15	1	PCB
16	IC16	1	PCB
17	IC17	1	PCB
18	IC18	1	PCB
19	IC19	1	PCB
20	IC20	1	PCB



PARTS LIST

■ ELECTRICAL PARTS

■ WARNING

- Components having special characteristics are marked  and must be replaced with parts having specifications equal to those originally installed.
- 印のある部分は、安全確保部品を示しています。部品の交換が必要な場合、パーツリストに記載されている部品を使用してください。
- 部品価格ランクは、予告なく変更することがあります。

ABBREVIATIONS IN THIS LIST ARE AS FOLLOWS:

C.A.EL.CHP	: CHIP ALUMI.ELECTROLYTIC CAP	L.EMIT	: LIGHT EMITTING MODULE
C.CE	: CERAMIC CAP	LED.DSPLY	: LED DISPLAY
C.CE.ARRAY	: CERAMIC CAP ARRAY	LED.INFRD	: LED,INFRARED
C.CE.CHP	: CHIP CERAMIC CAP	MODUL.RF	: MODULATOR,RF
C.CE.ML	: MULTILAYER CERAMIC CAP	PHOT.CPL	: PHOTO COUPLER
C.CE.M.CHP	: CHIP MULTILAYER CERAMIC CAP	PHOT.INTR	: PHOTO INTERRUPTER
C.CE.SAFTY	: RECOGNIZED CERAMIC CAP	PHOT.RFLCT	: PHOTO REFLECTOR
C.CE.TUBLR	: CERAMIC TUBULAR CAP	PIN.TEST	: PIN,TEST POINT
C.CE.SMI	: SEMI CONDUCTIVE CERAMIC CAP	PLST.RIVET	: PLASTIC RIVET
C.EL	: ELECTROLYTIC CAP	R.ARRAY	: RESISTOR ARRAY
C.MICA	: MICA CAP	R.CAR.	: CARBON RESISTOR
C.ML.FLM	: MULTILAYER FILM CAP	R.CAR.CHP	: CHIP RESISTOR
C.MP	: METALLIZED PAPER CAP	R.CAR.FP	: FLAME PROOF CARBON RESISTOR
C.MYLAR	: MYLAR FILM CAP	R.FUS	: FUSABLE RESISTOR
C.MYLAR.ML	: MULTILAYER MYLAR FILM CAP	R.MTL.CHP	: CHIP METAL FILM RESISTOR
C.PAPER	: PAPER CAPACITOR	R.MTL.FLM	: METAL FILM RESISTOR
C.PLS	: POLYSTYRENE FILM CAP	R.MTL.OXD	: METAL OXIDE FILM RESISTOR
C.POL	: POLYESTER FILM CAP	R.MTL.PLAT	: METAL PLATE RESISTOR
C.POLY	: POLYETHYLENE FILM CAP	RSNR.CE	: CERAMIC RESONATOR
C.PP	: POLYPROPYLENE FILM CAP	RSNR.CRYS	: CRYSTAL RESONATOR
C.TNTL	: TANTALUM CAP	R.TW.CEM	: TWIN CEMENT FIXED RESISTOR
C.TNTL.CHP	: CHIP TANTALUM CAP	R.WW	: WIRE WOUND RESISTOR
C.TRIM	: TRIMMER CAP	SCR.BND.HD	: BIND HEAD B-TITE SCREW
CN	: CONNECTOR	SCR.BW.HD	: BW HEAD TAPPING SCREW
CN.BS.PIN	: CONNECTOR,BASE PIN	SCR.CUP	: CUP TITE SCREW
CN.CANNON	: CONNECTOR,CANNON	SCR.TERM	: SCREW TERMINAL
CN.DIN	: CONNECTOR,DIN	SCR.TR	: SCREW,TRANSISTOR
CN.FLAT	: CONNECTOR,FLAT CABLE	SUPRT.PCB	: SUPPORT,P.C.B.
CN.POST	: CONNECTOR,BASE POST	SURG.PRTCT	: SURGE PROTECTOR
COIL.MX.AM	: COIL,AM MIX	SW.TACT	: TACT SWITCH
COIL.AT.FM	: COIL,FM ANTENNA	SW.LEAF	: LEAF SWITCH
COIL.DT.FM	: COIL,FM DETECT	SW.LEVER	: LEVER SWITCH
COIL.MX.FM	: COIL,FM MIX	SW.MICRO	: MICRO SWITCH
COIL.OUTPT	: OUTPUT COIL	SW.PUSH	: PUSH SWITCH
DIOD.ARRAY	: DIODE ARRAY	SW.RT.ENC	: ROTARY ENCODER
DIODE.BRG	: DIODE BRIDGE	SW.RT.MTR	: ROTARY SWITCH WITH MOTOR
DIODE.CHP	: CHIP DIODE	SW.RT	: ROTARY SWITCH
DIODE.VAR	: VARACTOR DIODE	SW.SLIDE	: SLIDE SWITCH
DIOD.Z.CHP	: CHIP ZENER DIODE	TERM.SP	: SPEAKER TERMINAL
DIODE.ZENR	: ZENER DIODE	TERM.WRAP	: WRAPPING TERMINAL
DSCR.CE	: CERAMIC DISCRIMINATOR	THRMST.CHP	: CHIP THERMISTOR
FER.BEAD	: FERRITE BEADS	TR.CHP	: CHIP TRANSISTOR
FER.CORE	: FERRITE CORE	TR.DGT	: DIGITAL TRANSISTOR
FET.CHP	: CHIP FET	TR.DGT.CHP	: CHIP DIGITAL TRANSISTOR
FL.DSPLY	: FLUORESCENT DISPLAY	TRANS	: TRANSFORMER
FLTR.CE	: CERAMIC FILTER	TRANS.PULS	: PULSE TRANSFORMER
FLTR.COMB	: COMB FILTER MODULE	TRANS.PWR	: POWER TRANSFORMER ASS'Y
FLTR.LC.RF	: LC FILTER,EMI	TUNER.AM	: TUNER PACK,AM
GND.MTL	: GROUND PLATE	TUNER.FM	: TUNER PACK,FM
GND.TERM	: GROUND TERMINAL	TUNER.PK	: FRONT-ENDTUNER PACK
HOLDER.FUS	: FUSE HOLDER	VR	: ROTARY POTENTIOMETER
IC.PRTCT	: IC PROTECTOR	VR.MTR	: POTENTIOMETER WITH MOTOR
JUMPER.CN	: JUMPER CONNECTOR	VR.SW	: POTENTIOMETER WITH ROTARY SW
JUMPER.TST	: JUMPER,TEST POINT	VR.SLIDE	: SLIDE POTENTIOMETER
L.DTCT	: LIGHT DETECTING MODULE	VR.TRIM	: TRIMMER POTENTIOMETER

Note) Those parts marked with “#” are not included in the P.C.B. ass'y.

P.C.B. FUNCTION

Schm Ref.	PART NO.	Description	Remarks	Markets	部 品 名	Rank	
*	WB976200	P. C. B.	FUNCTION		J	P C B 集成ファンク	
*	WB976300	P. C. B.	FUNCTION		UC	P C B 集成ファンク	
*	WB976400	P. C. B.	FUNCTION		TKABG	P C B 集成ファンク	
	CB501	VB389900	CN. BS. PIN	3P		ベースピン	01
	CB502	VB389900	CN. BS. PIN	3P		ベースピン	01
	CB503	VB389800	CN. BS. PIN	2P		ベースピン	01
*	CB504	VZ005700	TERM.	TP82223-22		ファストン端子	01
*	CB505	VZ005700	TERM.	TP82223-22		ファストン端子	01
	CB506	V3768800	SOCKET	17LE-23090-28		コネクタソケット	03
	CB507	V8446000	HOLDER. FUS	TP00335-31	JUC	ヒューズホルダー	
	CB508	V8446000	HOLDER. FUS	TP00335-31	JUC	ヒューズホルダー	
	CB508	VP206500	HOLDER. FUS	EYF-52BCT	TKABG	ヒューズホルダー	01
*	CB509	VZ005700	TERM.	TP82223-22		ファストン端子	01
*	CB510	VZ005700	TERM.	TP82223-22		ファストン端子	01
*	CB511	VZ005700	TERM.	TP82223-22		ファストン端子	01
*	CB512	VZ005700	TERM.	TP82223-22		ファストン端子	01
	CB513	VB390200	CN. BS. PIN	6P		コネクタベースポスト	01
	CB514	VP206500	HOLDER. FUS	EYF-52BCT	TKABG	ヒューズホルダー	01
	C501	V5690800	C. PP	220pF 100V		P P コン	
	C502	V5690800	C. PP	220pF 100V		P P コン	
*	C505	WB711700	C. EL	10uF 25V		ケミコン	
*	C506	WB711700	C. EL	10uF 25V		ケミコン	
*	C507	VE327200	C. POL. MLT	1uF 50V		積層マイラーコン	02
*	C508	VE327200	C. POL. MLT	1uF 50V		積層マイラーコン	02
*	C509	V5691300	C. PP	1000pF 100V		P P コン	
*	C510	V5691300	C. PP	1000pF 100V		P P コン	
	C511	VE326000	C. MYLAR. ML	0.1uF 50V		積層マイラーコン	01
	C512	VE326000	C. MYLAR. ML	0.1uF 50V		積層マイラーコン	01
*	C513	VL972900	C. PP	330pF 200V		P P コン	01
*	C514	VL972900	C. PP	330pF 200V		P P コン	01
*	C515	WA245600	C. PP	820pF 100V		P P コン	
*	C516	WA245600	C. PP	820pF 100V		P P コン	
*	C517	UT552680	C. PP	680pF 125V		P P コン P C U	
*	C518	UT552680	C. PP	680pF 125V		P P コン P C U	
*	C519	UT553180	C. PP	1800pF 125V		P P コン P C U	
*	C520	UT553180	C. PP	1800pF 125V		P P コン P C U	
*	C521	FU451680	C. MICA	68pF 500V		マイカコン	01
*	C522	FU451680	C. MICA	68pF 500V		マイカコン	01
*	C523	FU451680	C. MICA	68pF 500V		マイカコン	01
*	C524	FU451680	C. MICA	68pF 500V		マイカコン	01
	C525	VE326000	C. MYLAR. ML	0.1uF 50V		積層マイラーコン	01
	C526	VE326000	C. MYLAR. ML	0.1uF 50V		積層マイラーコン	01
	C527	VE326000	C. MYLAR. ML	0.1uF 50V		積層マイラーコン	01
	C528	VE326000	C. MYLAR. ML	0.1uF 50V		積層マイラーコン	01
*	C529	WB712100	C. EL	100uF 25V		ケミコン	
*	C530	WB712100	C. EL	100uF 25V		ケミコン	
*	C531	WB712100	C. EL	100uF 25V		ケミコン	
*	C532	WB712100	C. EL	100uF 25V		ケミコン	
	C536	UM397100	C. EL	10uF 16V		ケミコン	01
	C538	V5900200	C. MYLAR	1uF 250V		マイラーコン	04
	C543	V5900200	C. MYLAR	1uF 250V		マイラーコン	04
⚠	C545	V6146500	C. CE. SAFTY	1000pF 250V	TKABG	規格認定コン K H	01
⚠	C546	V6146500	C. CE. SAFTY	1000pF 250V	TKABG	規格認定コン K H	01

* New Parts * 新規部品(マーク#の部品は、基板に含まれません)

P.C.B. FUNCTION

Schm Ref.	PART NO.	Description	Remarks	Markets	部 品 名	Rank
	C547	UM397100 C. EL	10uF 16V		ケミコン	01
△	C548	V6146600 C. CE. SAFTY	2200pF 250V	JUC	規格認定コン	
△	C548	V6146500 C. CE. SAFTY	1000pF 250V	TKABG	規格認定コン K H	01
△	C549	V6146600 C. CE. SAFTY	2200pF 250V	JUC	規格認定コン	
△	C549	V6146500 C. CE. SAFTY	1000pF 250V	TKABG	規格認定コン K H	01
△	C550	V6146500 C. CE. SAFTY	1000pF 250V	TKABG	規格認定コン	
△	C551	V5900200 C. MYLAR	1uF 250V		マイラーコン	04
△	C552	V6146500 C. CE. SAFTY	1000pF 250V		規格認定コン	
*	C553	WB687100 C. POL. MTL	0.047uF 400V	JUC	メタライズドポリコン	
*	C553	WC041600 C. PP	0.022uF 630V	TKABG	P P コン	
	C554	UR866100 C. EL	1uF 50V		ケミコン	01
	C555	UA653470 C. MYLAR	4700pF 50V		マイラーコン	01
	C556	UA654100 C. MYLAR	0.01uF 50V		マイラーコン	01
	C557	UA654100 C. MYLAR	0.01uF 50V		マイラーコン	01
	C558	UR858470 C. EL	470uF 35V		ケミコン	01
	C559	UR858470 C. EL	470uF 35V		ケミコン	01
	C560	V6887300 C. MYLAR	0.1uF 250V	JUC	コンデンサ	
	C561	UR858100 C. EL	100uF 35V		ケミコン	01
*	C562	WB687100 C. POL. MTL	0.047uF 400V	TKABG	メタライズドポリコン	
	C563	UR858100 C. EL	100uF 35V		ケミコン	01
	C566	UR847100 C. EL	10uF 25V		ケミコン	01
*	C567	UT754820 C. PP	0.082uF 100V		P P コン	
*	C568	UT754820 C. PP	0.082uF 100V		P P コン	
*	C569	UT754820 C. PP	0.082uF 100V		P P コン	
*	C570	UT754820 C. PP	0.082uF 100V		P P コン	
	C571	UR847100 C. EL	10uF 25V		ケミコン	01
	C572	UA654560 C. MYLAR	0.056uF 50V		マイラーコン	
	C573	UA654560 C. MYLAR	0.056uF 50V		マイラーコン	
	C574	UA654100 C. MYLAR	0.01uF 50V		マイラーコン	01
	C575	UA654100 C. MYLAR	0.01uF 50V		マイラーコン	01
	C576	UR858100 C. EL	100uF 35V		ケミコン	01
	C577	UR749220 C. EL	2200uF 25V		ケミコン	03
	C578	UR865470 C. EL	0.47uF 50V		ケミコン	01
	C579	UR866100 C. EL	1uF 50V		ケミコン	01
	C585	UR867220 C. EL	22uF 50V		ケミコン	01
* △	C595	WD123200 C. CE. SAFTY	470pF 250V	TKABG	規格認定コン	
* △	C596	WD123200 C. CE. SAFTY	470pF 250V	TKABG	規格認定コン	
	D501	VT332900 D10DE	1SS355		ダイオード	01
	D502	VT332900 D10DE	1SS355		ダイオード	01
	D503	VT332900 D10DE	1SS355		ダイオード	01
	D504	VT332900 D10DE	1SS355		ダイオード	01
	D505	VT332900 D10DE	1SS355		ダイオード	01
	D506	VT332900 D10DE	1SS355		ダイオード	01
	D507	VT332900 D10DE	1SS355		ダイオード	01
	D508	VT332900 D10DE	1SS355		ダイオード	01
	D509	VT332900 D10DE	1SS355		ダイオード	01
	D510	VT332900 D10DE	1SS355		ダイオード	01
	D512	VU994200 D10DE. ZENR	MA8075-M 7.5V		ツェナーダイオード	01
	D513	VT332900 D10DE	1SS355		ダイオード	01
	D514	VT332900 D10DE	1SS355		ダイオード	01
	D515	VU995400 D10DE. ZENR	MA8100-M 10V		ツェナーダイオード	01
	D516	VT332900 D10DE	1SS355		ダイオード	01
△	D517	VR253700 D10DE. BRG	S1NB20 1A 200V		D I ブリッジ X 4	02

* New Parts * 新規部品(マーク#の部品は、基板に含まれません)

P.C.B. FUNCTION

Schm Ref.	PART NO.	Description	Remarks	Markets	部 品 名	Rank		
△	D518	VR253700	D10DE. BRG	S1NB20 1A 200V		D I ブリッジ X 4	02	
	D519	VT332900	D10DE	1SS355		ダイオード	01	
*	△	D520	V4756800	D10DE	S1NB60 1.0A 600V	D i スタック		
	D521	VT332900	D10DE	1SS355		ダイオード	01	
	D522	VT332900	D10DE	1SS355		ダイオード	01	
	D523	VT332900	D10DE	1SS355		ダイオード	01	
	D524	VT332900	D10DE	1SS355		ダイオード	01	
	D525	VT332900	D10DE	1SS355		ダイオード	01	
△	D526	VR253700	D10DE. BRG	S1NB20 1A 200V		D I ブリッジ X 4	02	
△	D527	VR253700	D10DE. BRG	S1NB20 1A 200V		D I ブリッジ X 4	02	
	D528	VT332900	D10DE	1SS355		ダイオード	01	
*	D529	VU993300	D10DE. ZENR	MA8062-L 6.0V		ツェナーダイオード		
	D530	VT332900	D10DE	1SS355		ダイオード	01	
	D531	VT332900	D10DE	1SS355		ダイオード	01	
	D532	VT332900	D10DE	1SS355		ダイオード	01	
	D533	VT332900	D10DE	1SS355		ダイオード	01	
	D534	VT332900	D10DE	1SS355		ダイオード	01	
*	F501	V8932000	FUSE	25A 250V	J	ヒューズ 2 5 0 V	03	
	F501	V8932100	FUSE	20A 250V	UC	ヒューズ 2 5 0 V	03	
	F501	V5413700	FUSE	TH10A 250V IEC	TKABG	ヒューズ 2 5 0 V	01	
	IC501	XW863A00	IC	ADM202JRN-REEL7		I C	05	
	IC502	iG001180	IC	TC4013BP FF		ロジック I C	05	
△	IC503	XJ603A00	IC	NJM78M15FA		I C	02	
△	IC504	XJ603A00	IC	NJM78M15FA		I C	02	
△	IC505	V8100500	PHOT. CPL	TLP421 GR		フォトカプラ	01	
*	IC506	X4466A00	IC	BD4825G-TR		リセット I C		
*	JK501	VL744500	CN. CANNON	HA16PRM-3SE		キャノンコネクタ	10	
*	JK502	VL744500	CN. CANNON	HA16PRM-3SE		キャノンコネクタ	10	
	JK503	VJ726800	JACK. MNI			モノラルミニジャック	01	
	JK504	VJ726800	JACK. MNI			モノラルミニジャック	01	
*	△	L501	WC747400	COIL	SC-11-20J-W	JUC	コイル	
*	△	L501	WC747500	COIL	SC-07-08J-W	TKABG	コイル	
*	△	L502	WC747400	COIL	SC-11-20J-W	JUC	コイル	
*	△	L502	WC747500	COIL	SC-07-08J-W	TKABG	コイル	
*	△	L503	WC550500	COIL	KTS20L1 L	JUC	リアクトル	
*	△	L503	WC550600	COIL	KTS20H1 H	TKABG	リアクトル	
*	△	L504	WC550500	COIL	KTS20L1 L	JUC	リアクトル	
*	△	L504	WC550600	COIL	KTS20H1 H	TKABG	リアクトル	
*	△	L505	VR929200	COIL	10uH		コイル	01
*	△	L506	VR929200	COIL	10uH		コイル	01
*	L507	WB473700	COIL	#C3B-A0317		コイル		
*	L508	WB473700	COIL	#C3B-A0317		コイル		
*	L531	WC659700	COIL	ESD-H-14NU		コイル		
*	L532	WC659700	COIL	ESD-H-14NU		コイル		
*	△	L601	WD132800	COIL	SU10VD-10050	UCTKABG	S U コイル 1 A	
*	△	L602	WD100700	COIL	SU9VF-02100 10mH	UCTKABG	コモンモードコイル	
*	PJ501	WA867300	JACK. PIN	1P WH WBT-0234		ピンジャック 1 P		
*	PJ502	WC025800	JACK. PIN	1P RE WBT-0234		ピンジャック 1 P		
	PN501	V9637500	PIN	L=70 #18		スタイルピン		
	PN503	V9637500	PIN	L=70 #18		スタイルピン		
	PN504	V9637500	PIN	L=70 #18		スタイルピン		
*	Q501	WA780400	FET	2SK369 G, R		F E T		
*	Q502	WA780400	FET	2SK369 G, R		F E T		

* New Parts * 新規部品(マーク#の部品は、基板に含まれません)

P.C.B. FUNCTION

Schm Ref.	PART NO.	Description	Remarks	Markets	部 品 名	Rank
0503	iA101590	TR	2SA1015 0, Y		トランジスタ	01
0504	iA101590	TR	2SA1015 0, Y		トランジスタ	01
0505	iA101590	TR	2SA1015 0, Y		トランジスタ	01
0506	iA101590	TR	2SA1015 0, Y		トランジスタ	01
0507	iC1815M0	TR	2SC1815 Y, GR		トランジスタ	01
0508	iC1815M0	TR	2SC1815 Y, GR		トランジスタ	01
* 0509	WA780400	FET	2SK369 G, R		F E T	
* 0510	WA780400	FET	2SK369 G, R		F E T	
0511	iC1815M0	TR	2SC1815 Y, GR		トランジスタ	01
0512	iC1815M0	TR	2SC1815 Y, GR		トランジスタ	01
0513	iA101590	TR	2SA1015 0, Y		トランジスタ	01
0514	iC1815M0	TR	2SC1815 Y, GR		トランジスタ	01
0515	iC1815M0	TR	2SC1815 Y, GR		トランジスタ	01
0516	iA101590	TR	2SA1015 0, Y		トランジスタ	01
0517	iC1815M0	TR	2SC1815 Y, GR		トランジスタ	01
0518	iA101590	TR	2SA1015 0, Y		トランジスタ	01
0519	iA101590	TR	2SA1015 0, Y		トランジスタ	01
0520	iC1815M0	TR	2SC1815 Y, GR		トランジスタ	01
△ 0521	VV556500	TR	2SA1037K Q, R, S		トランジスタ	01
0523	VP872600	TR	2SA1708 S, T		トランジスタ	01
* 0524	WB520400	FET. CHP	2SK2823		チップ F E T	
* △ 0525	WB532800	FET	2SK3342	J	F E T	
* △ 0525	WC021300	FET	2SK3373	UC	F E T	
* △ 0525	WC219600	FET	2SK2865	TKABG	F E T	
0528	VV655700	TR. DGT	DTC144EKA		デジタルトランジスタ	01
0529	VV655300	TR. DGT	DTA144EKA		デジタルトランジスタ	01
0530	VZ725900	TR	2SD1938F S, T		トランジスタ	
0531	VZ725900	TR	2SD1938F S, T		トランジスタ	
R545	HV755270	R. CAR. FP	270 Ω 1/4W		不燃化カーボン抵抗	01
R546	HV755270	R. CAR. FP	270 Ω 1/4W		不燃化カーボン抵抗	01
* △ R560	VN067400	R. WW	6.8 Ω 5W		セメント抵抗	03
* △ R561	VN067400	R. WW	6.8 Ω 5W		セメント抵抗	03
R562	HV756470	R. CAR. FP	4.7K Ω 1/4W	JUC	不燃化カーボン抵抗	01
R562	HV757100	R. CAR. FP	10K Ω 1/4W	TKABG	不燃化カーボン抵抗	01
R563	HV756470	R. CAR. FP	4.7K Ω 1/4W	JUC	不燃化カーボン抵抗	01
R563	HV757100	R. CAR. FP	10K Ω 1/4W	TKABG	不燃化カーボン抵抗	01
* R569	HL234100	R. MTL. OXD	10 Ω 3W		酸化金属被膜抵抗	
* R570	HL234100	R. MTL. OXD	10 Ω 3W		酸化金属被膜抵抗	
R571	HV754820	R. CAR. FP	82 Ω 1/4W		不燃化カーボン抵抗	01
R572	HV754820	R. CAR. FP	82 Ω 1/4W		不燃化カーボン抵抗	01
* RY501	V8616500	RELAY	DC G6S-2		リレー 1 2 V	04
* RY502	V8616500	RELAY	DC G6S-2		リレー 1 2 V	04
* RY507	WA851100	RELAY	DC JM1AN-P-DC12V		リレー 1 2 V	
* RY508	WA851100	RELAY	DC JM1AN-P-DC12V		リレー 1 2 V	
RY509	KC001410	RELAY	DC JC2AD-DC24V		リレー 2 4 V	07
RY511	KC001410	RELAY	DC JC2AD-DC24V		リレー 2 4 V	07
* SW501	V4770200	SW. SLIDE	SSAA22-B		スライド SW	
* SW502	WB854200	SW. PUSH	SPUP192000 2		プッシュ SW	
* SW503	V4770200	SW. SLIDE	SSAA22-B		スライド SW	
* SW504	V9632200	SW. DIP	JKS3121-0106		ディップ SW	
* SW505	VV011000	SW. TACT	SKHLLC		タクト SW	01
* △ T501	X4475A00	TRANS		J	サブトランス	
* △ T501	X4476A00	TRANS		UC	サブトランス	

* New Parts * 新規部品(マーク#の部品は、基板に含まれません)

P.C.B. FUNCTION & P.C.B. OPERATION

Schm Ref.	PART NO.	Description	Remarks	Markets	部 品 名	Rank	
* △	T501	X4477A00	TRANS		TKABG	サブトランス	
* △	T502	X4037A00	TRANS		J	サブトランス	
* △	T502	X4133A00	TRANS		UC	サブトランス	
* △	T502	X4134A00	TRANS		TKABG	サブトランス	
*	TP651	VE340300	PIN. TEST	IRS-1169		テストポイントピン	01
		WB838000	PLATE			シールドプレート	
*		WB976500	P. C. B.	OPERATION		P C B オペレーション	
	CB701	VB390400	CN. BS. PIN	8P		ベースピン	01
	CB702	VB390600	CN. BS. PIN	10P		コネクタベースポスト	01
	CB703	VB390700	CN. BS. PIN	11P		コネクタベースポスト	01
	CB704	VB390700	CN. BS. PIN	11P		コネクタベースポスト	01
	C708	VT180400	C. EL	4700uF 5.5V		バックアップケミコン	02
	C709	UR838100	C. EL	100uF 16V		ケミコン	01
	C711	UR865220	C. EL	0.22uF 50V		ケミコン	01
	C714	UR837470	C. EL	47uF 16V		ケミコン	01
	C715	V3694000		4.7uF 10V		ケミコン	01
	C718	UR847100	C. EL	10uF 25V		ケミコン	01
	C719	UR847100	C. EL	10uF 25V		ケミコン	01
	C722	UR847100	C. EL	10uF 25V		ケミコン	01
	D701	VU992600	DIODE. ZENR	MA8051-M 5.1V		ツェナーダイオード	01
	D702	VU992600	DIODE. ZENR	MA8051-M 5.1V		ツェナーダイオード	01
	D703	VU992600	DIODE. ZENR	MA8051-M 5.1V		ツェナーダイオード	01
	D704	VU992600	DIODE. ZENR	MA8051-M 5.1V		ツェナーダイオード	01
△	D705	VV833200	DIODE	1SS380		ダイオード	01
	D707	VT332900	DIODE	1SS355		ダイオード	01
*	D708	WB108100	LED. CHP	BE SML311BBT		チップLED	
*	D709	WB108100	LED. CHP	BE SML311BBT		チップLED	
*	D710	WB108000	LED. CHP	RE SML-310LT		チップLED	
*	D711	WB108000	LED. CHP	RE SML-310LT		チップLED	
	D712	VT332900	DIODE	1SS355		ダイオード	01
* △	IC703	X5244A00	IC	AN78L12 12V		電源IC	
*	IC704	X5041A00	IC	NJU7201L55 5.5V		電源IC SIL	
	Q701	VV556400	TR	2SC2412K Q, R, S		トランジスタ	01
	Q702	VV655300	TR. DGT	DTA144EKA		デジタルトランジスタ	01
	Q703	VV655700	TR. DGT	DTC144EKA		デジタルトランジスタ	01
	Q704	VV556400	TR	2SC2412K Q, R, S		トランジスタ	01
	Q705	VV655700	TR. DGT	DTC144EKA		デジタルトランジスタ	01
	Q706	VV556400	TR	2SC2412K Q, R, S		トランジスタ	01
	Q707	VV655400	TR. DGT	DTC114EKA		デジタルトランジスタ	01
	Q708	VV655000	TR. DGT	DTA114EKA		デジタルトランジスタ	01
	Q709	VV655700	TR. DGT	DTC144EKA		デジタルトランジスタ	01
	Q710	VV556400	TR	2SC2412K Q, R, S		トランジスタ	01
	Q711	VV655300	TR. DGT	DTA144EKA		デジタルトランジスタ	01
	Q713	VG805500	TR	2SC4391 R, S		トランジスタ	01
	Q714	VV556400	TR	2SC2412K Q, R, S		トランジスタ	01
△	Q715	VP872600	TR	2SA1708 S, T		トランジスタ	01
	Q716	VV655700	TR. DGT	DTC144EKA		デジタルトランジスタ	01
	Q717	VV655700	TR. DGT	DTC144EKA		デジタルトランジスタ	01
	Q718	VV556400	TR	2SC2412K Q, R, S		トランジスタ	01
	Q719	VG805500	TR	2SC4391 R, S		トランジスタ	01

* New Parts * 新規部品(マーク#の部品は、基板に含まれません)

P.C.B. OPERATION & P.C.B. MAIN

Schm Ref.	PART NO.	Description	Remarks	Markets	部 品 名	Rank
Q720	VV655700	TR. DGT	DTC144EKA		デジタルトランジスタ	01
Q722	VG805500	TR	2SC4391 R, S		トランジスタ	01
Q723	VV556500	TR	2SA1037K Q, R, S		トランジスタ	01
R765	HV755180	R. CAR. FP	180Ω 1/4W		不燃化カーボン抵抗	01
R766	HV755180	R. CAR. FP	180Ω 1/4W		不燃化カーボン抵抗	01
R771	HV754100	R. CAR. FP	10Ω 1/4W		不燃化カーボン抵抗	01
SW701	WB191500	SW. PUSH	SPPH130100		プッシュSW	
XL701	WC621700	RSNR. CRYST	11.2896MHz SMD-49		水晶振動子	
	WB836900	REFLECTOR			リフレクター／LED	
	WB975900	P. C. B.	MAIN	J	P C B メイン	
	WB976000	P. C. B.	MAIN	UC	P C B メイン	
	WB976100	P. C. B.	MAIN	TKABG	P C B メイン	
CB101	VB390200	CN. BS. PIN	6P		コネクタベースポスト	01
CB102	VB390100	CN. BS. PIN	5P		ベースピン	01
CB103	VZ005700	TERM.	TP82223-22		ファストン端子	01
CB104	VZ005700	TERM.	TP82223-22		ファストン端子	01
CB105	VB390700	CN. BS. PIN	11P		コネクタベースポスト	01
CB106	VG879900	CN. BS. PIN	2P		ベースピン	01
CB107	VB389800	CN. BS. PIN	2P		ベースピン	01
CB108	VB390100	CN. BS. PIN	5P		ベースピン	01
C102	VE326000	C. MYLAR. ML	0.1uF 50V		積層マイラーコン	01
C103	WB712100	C. EL	100uF 25V		ケミコン	
C104	VE326000	C. MYLAR. ML	0.1uF 50V		積層マイラーコン	01
C105	WB712100	C. EL	100uF 25V		ケミコン	
C106	FU452150	C. MICA	150pF 500V		マイカコン	
C107	UR847330	C. EL	33uF 25V		ケミコン	01
C108	FU451200	C. MICA	20pF 500V		マイカコン	
C109	FU451470	C. MICA	47pF 500V		マイカコン	01
C110	VE327200	C. POL. MLT	1uF 50V		積層マイラーコン	02
C111	VE327200	C. POL. MLT	1uF 50V		積層マイラーコン	02
C112	FU452150	C. MICA	150pF 500V		マイカコン	
C113	UT553120	C. PP	1200pF 125V		PPコンPCU	
C114	WB712100	C. EL	100uF 25V		ケミコン	
C115	WB712100	C. EL	100uF 25V		ケミコン	
C116	FU452100	C. MICA	100pF 500V		マイカコン	01
C119	VE326000	C. MYLAR. ML	0.1uF 50V		積層マイラーコン	01
C120	VE326000	C. MYLAR. ML	0.1uF 50V		積層マイラーコン	01
C121	VE326000	C. MYLAR. ML	0.1uF 50V		積層マイラーコン	01
C122	VE326000	C. MYLAR. ML	0.1uF 50V		積層マイラーコン	01
C126	UA654470	C. MYLAR	0.047uF 50V		マイラーコン	01
C127	UA652470	C. MYLAR	470pF 50V		マイラーコン	01
C128	UA653100	C. MYLAR	1000pF 50V		マイラーコン	03
C129	UR847100	C. EL	10uF 25V		ケミコン	01
C130	UR847100	C. EL	10uF 25V		ケミコン	01
C131	VE326000	C. MYLAR. ML	0.1uF 50V		積層マイラーコン	01
C132	VE326000	C. MYLAR. ML	0.1uF 50V		積層マイラーコン	01
C133	UA654100	C. MYLAR	0.01uF 50V		マイラーコン	01
C134	UR847100	C. EL	10uF 25V		ケミコン	01
C136	WB711700	C. EL	10uF 25V		ケミコン	
C137	UR866100	C. EL	1uF 50V		ケミコン	01

* New Parts * 新規部品(マーク#の部品は、基板に含まれません)

P.C.B. MAIN

Schm Ref.	PART NO.	Description	Remarks	Markets	部 品 名	Rank	
C138	UR866100	C. EL	1uF	50V		ケミコン	01
C140	UA654470	C. MYLAR	0.047uF	50V		マイラーコン	01
C141	FU451150	C. MICA	15pF	500V		マイカコン	01
C142	UA653100	C. MYLAR	1000pF	50V		マイラーコン	03
C148	UA652100	C. MYLAR	100pF	50V		マイラーコン	01
C153	UR847100	C. EL	10uF	25V		ケミコン	01
* C154	WB712100	C. EL	100uF	25V		ケミコン	
* C155	WB712100	C. EL	100uF	25V		ケミコン	
C156	UR847100	C. EL	10uF	25V		ケミコン	01
C159	VE326000	C. MYLAR. ML	0.1uF	50V		積層マイラーコン	01
C160	VE326000	C. MYLAR. ML	0.1uF	50V		積層マイラーコン	01
C164	UR847100	C. EL	10uF	25V		ケミコン	01
C173	UA652330	C. MYLAR	330pF	50V		マイラーコン	01
* C179	WB712100	C. EL	100uF	25V		ケミコン	
* C181	WB712100	C. EL	100uF	25V		ケミコン	
C186	UA653470	C. MYLAR	4700pF	50V		マイラーコン	01
C187	UA653470	C. MYLAR	4700pF	50V		マイラーコン	01
* C190	WB080800	C. PP	1uF	250V		P Pコン	
* C191	WB080800	C. PP	1uF	250V		P Pコン	
* C192	WA978200	C. PP	1.5uF	250V		P Pコン	
* C196	WB810900	C. EL	1200uF	160V		ケミコン	
* C197	WB810900	C. EL	1200uF	160V		ケミコン	
* C198	WB810900	C. EL	1200uF	160V		ケミコン	
* C199	WB810900	C. EL	1200uF	160V		ケミコン	
* C200	WB677200	C. OS	33uF	16V		O Sコン	
* C201	WB677200	C. OS	33uF	16V		O Sコン	
C203	VE326600	C. MYLAR. ML	0.33uF	50V		積層マイラーコン	01
C204	VE326600	C. MYLAR. ML	0.33uF	50V		積層マイラーコン	01
* C205	WB000000	S. EL	1000uF	25V		ケミコン PW	
* C206	WB000000	S. EL	1000uF	25V		ケミコン PW	
C210	VE326000	C. MYLAR. ML	0.1uF	50V		積層マイラーコン	01
C211	VE326000	C. MYLAR. ML	0.1uF	50V		積層マイラーコン	01
C212	VE326000	C. MYLAR. ML	0.1uF	50V		積層マイラーコン	01
C213	VE326000	C. MYLAR. ML	0.1uF	50V		積層マイラーコン	01
* C214	WB797900	C. EL	680uF	35V		ケミコン PW	
* C215	WB797900	C. EL	680uF	35V		ケミコン PW	
* C217	WA980500	C. PP	1uF	250V	J	P Pコン	
* C217	WA981400	C. PP	0.82uF	250V	UCTKABG	P Pコン	
C220	VE326000	C. MYLAR. ML	0.1uF	50V		積層マイラーコン	01
C221	UR867100	C. EL	10uF	50V		ケミコン	01
* C222	WB532600	C. EL	1500uF	180V	J	ケミコン	
* C222	WB532700	C. EL	1300uF	200V	UCTKABG	ケミコン	
* C223	WB532600	C. EL	1500uF	180V	J	ケミコン	
* C223	WB532700	C. EL	1300uF	200V	UCTKABG	ケミコン	
C225	UR867100	C. EL	10uF	50V		ケミコン	01
C226	UR867100	C. EL	10uF	50V		ケミコン	01
C231	UA653470	C. MYLAR	4700pF	50V		マイラーコン	01
C232	UA652680	C. MYLAR	680pF	50V		マイラーコン	01
* C233	UA352750	C. MYLAR	750pF	50V		マイラーコン	01
C237	UR865470	C. EL	0.47uF	50V		ケミコン	01
C238	UR865470	C. EL	0.47uF	50V		ケミコン	01
⚠ C239	VY675100	C. CE. SAFTY	4700pF	250V		規格認定コン	
⚠ C240	VY675100	C. CE. SAFTY	4700pF	250V		規格認定コン	

* New Parts * 新規部品(マーク#の部品は、基板に含まれません)

P.C.B. MAIN

Schm Ref.	PART NO.	Description	Remarks	Markets	部 品 名	Rank
C246	UT553220	C. PP	2200pF 125V		P P コン	03
C247	UT553220	C. PP	2200pF 125V		P P コン	03
D101	VT332900	D10DE	1SS355		ダイオード	01
D102	VT332900	D10DE	1SS355		ダイオード	01
D103	VT332900	D10DE	1SS355		ダイオード	01
D104	VT332900	D10DE	1SS355		ダイオード	01
D105	VT332900	D10DE	1SS355		ダイオード	01
D106	VT332900	D10DE	1SS355		ダイオード	01
D107	VT332900	D10DE	1SS355		ダイオード	01
D108	VT332900	D10DE	1SS355		ダイオード	01
D109	V2379000	D10DE	11EQS04		ダイオード	01
D110	V2379000	D10DE	11EQS04		ダイオード	01
D111	VT332900	D10DE	1SS355		ダイオード	01
D112	VT332900	D10DE	1SS355		ダイオード	01
D113	VT332900	D10DE	1SS355		ダイオード	01
D114	VT332900	D10DE	1SS355		ダイオード	01
D115	VT332900	D10DE	1SS355		ダイオード	01
D116	VT332900	D10DE	1SS355		ダイオード	01
* D117	VU991800	D10DE. ZENR	MA8043-M 4.3V		ツェナーダイオード	
* D118	VU990200	D10DE. ZENR	MA8027-L 2.6V		ツェナーダイオード	
* D119	VU990200	D10DE. ZENR	MA8027-L 2.6V		ツェナーダイオード	
D120	VT332900	D10DE	1SS355		ダイオード	01
D121	VT332900	D10DE	1SS355		ダイオード	01
D122	VT332900	D10DE	1SS355		ダイオード	01
D123	VT332900	D10DE	1SS355		ダイオード	01
D124	VT332900	D10DE	1SS355		ダイオード	01
D125	VT332900	D10DE	1SS355		ダイオード	01
D126	VT332900	D10DE	1SS355		ダイオード	01
D127	VT332900	D10DE	1SS355		ダイオード	01
* D130	VV664800	D10DE. ZENR	RLZ36.0B 36.0V		ツェナーダイオード	
* D131	VV664800	D10DE. ZENR	RLZ36.0B 36.0V		ツェナーダイオード	
* ⚠ D132	WB687000	D10DE	SF20SC4 20A 40V		ショットキダイオード	
* ⚠ D133	WB687000	D10DE	SF20SC4 20A 40V		ショットキダイオード	
* D134	WB475800	D10DE	RL3LF014-302		ダイオード	
* D135	WB475800	D10DE	RL3LF014-302		ダイオード	
* D136	WB475800	D10DE	RL3LF014-302		ダイオード	
* D137	WB475800	D10DE	RL3LF014-302		ダイオード	
* D138	WB475800	D10DE	RL3LF014-302		ダイオード	
* D139	WB475800	D10DE	RL3LF014-302		ダイオード	
* D142	VU996600	D10DE. ZENR	MA8130-M 13.0V		ツェナーダイオード	
* D143	VU996600	D10DE. ZENR	MA8130-M 13.0V		ツェナーダイオード	
* D144	WB475600	D10DE	EL1LF-H5K		ダイオード	
⚠ D146	VN399500	D10DE. BRG	FMU-36S 20.0A 600V		D i スタック	05
⚠ D148	V8498700	D10DE	FMU-36R 20.0A 600V		ダイオード	04
* ⚠ D149	VN478200	D10DE	D1NL20U		ダイオード	01
* ⚠ D150	VN478200	D10DE	D1NL20U		ダイオード	01
D151	V2379000	D10DE	11EQS04		ダイオード	01
D152	V2379000	D10DE	11EQS04		ダイオード	01
* D153	WB475600	D10DE	EL1LF-H5K		ダイオード	
⚠ D156	VN399300	D10DE	FMU-12S 5A 200V		D i スタック	03
⚠ D158	VN399400	D10DE	FMU-12R 5A 200V		D i スタック	03
* D159	VN478200	D10DE	D1NL20U		ダイオード	01
D160	VT332900	D10DE	1SS355		ダイオード	01

* New Parts * 新規部品(マーク#の部品は、基板に含まれません)

P.C.B. MAIN

Schm Ref.	PART NO.	Description	Remarks	Markets	部 品 名	Rank
D161	VT332900	D10DE	1SS355		ダイオード	01
D162	VT332900	D10DE	1SS355		ダイオード	01
D163	VT332900	D10DE	1SS355		ダイオード	01
* D164	VN478200	D10DE	D1NL20U		ダイオード	01
* ⚠ D165	V8629800	D10DE	AG01A WS		ダイオード	01
D166	VU992200	D10DE. ZENR	MA8047-M 4.7V		ツェナーダイオード	
D167	VU992200	D10DE. ZENR	MA8047-M 4.7V		ツェナーダイオード	
* ⚠ D168	WB730100	D10DE. BRG	LN25XB60 25A 600V		ダイオードスタック	
* D169	VU997600	D10DE. ZENR	MA8160-H 16.7V		ツェナーダイオード	
* D170	VU997600	D10DE. ZENR	MA8160-H 16.7V		ツェナーダイオード	
* D171	VU997600	D10DE. ZENR	MA8160-H 16.7V		ツェナーダイオード	
* D172	VU997600	D10DE. ZENR	MA8160-H 16.7V		ツェナーダイオード	
D173	VT332900	D10DE	1SS355		ダイオード	01
D174	VT332900	D10DE	1SS355		ダイオード	01
D175	VT332900	D10DE	1SS355		ダイオード	01
D176	VT332900	D10DE	1SS355		ダイオード	01
D177	VT332900	D10DE	1SS355		ダイオード	01
* D178	VN478200	D10DE	D1NL20U		ダイオード	01
* D179	VN478200	D10DE	D1NL20U		ダイオード	01
* D180	VV664800	D10DE. ZENR	RLZ36.0B 36.0V		ツェナーダイオード	
* IC101	XC458A00	IC	NJM072M		IC	03
⚠ IC105	XJ604A00	IC	NJM78M05FA		IC	02
⚠ IC106	XE436A00	IC	NJM79M05FA		IC	03
* IC107	X3129A00	IC	YDA133-E		IC	
* IC108	WB044400	PHOT. CPL	PC411LONIP		フォトカブラ	
IC109	X0515A00	IC	LM61CIZ THERMAL		電源IC	
* IC110	WB044400	PHOT. CPL	PC411LONIP		フォトカブラ	
* IC111	WB044400	PHOT. CPL	PC411LONIP		フォトカブラ	
* IC112	WB058200	PHOT. CPL	TLP281 GR		フォトカブラ	
* IC115	XC458A00	IC	NJM072M		IC	03
* IC116	WB058200	PHOT. CPL	TLP281 GR		フォトカブラ	
* IC118	X3130A00	IC	YDA134-E		IC	
* IC119	X3130A00	IC	YDA134-E		IC	
* ⚠ IC121	X4508A00	IC	AN7712SP-E1		電源IC	
* ⚠ IC122	X4508A00	IC	AN7712SP-E1		電源IC	
⚠ IC123	XJ603A00	IC	NJM78M15FA		IC	02
⚠ IC124	XG505A00	IC	NJM79M15FA		IC	03
IC125	V8100500	PHOT. CPL	TLP421 GR		フォトカブラ	01
* IC127	WD015400	PHOT. CPL	HCNW2601		フォトカブラ	
* IC128	WD015400	PHOT. CPL	HCNW2601		フォトカブラ	
⚠ IC129	X2382A00	IC	IR2110		ドライバーIC	06
IC130	XB738A00	IC	TC4053BF MULTI-PLX		IC	02
* L101	WB473600	COIL	#C3B-A0373		コイル	
Q101	VG805500	TR	2SC4391 R, S		トランジスタ	01
Q102	VV655300	TR. DGT	DTA144EKA		デジタルトランジスタ	01
Q103	VV556500	TR	2SA1037K Q, R, S		トランジスタ	01
Q104	VV556400	TR	2SC2412K Q, R, S		トランジスタ	01
Q105	VV556500	TR	2SA1037K Q, R, S		トランジスタ	01
Q106	VV556400	TR	2SC2412K Q, R, S		トランジスタ	01
Q107	VV556400	TR	2SC2412K Q, R, S		トランジスタ	01
Q108	VV655700	TR. DGT	DTC144EKA		デジタルトランジスタ	01
Q109	VV556400	TR	2SC2412K Q, R, S		トランジスタ	01
Q110	VV556500	TR	2SA1037K Q, R, S		トランジスタ	01

* New Parts * 新規部品(マーク#の部品は、基板に含まれません)

P.C.B. MAIN

Schm Ref.	PART NO.	Description	Remarks	Markets	部 品 名	Rank
Q111	VV556400	TR	2SC2412K Q, R, S		トランジスタ	01
Q112	VV556500	TR	2SA1037K Q, R, S		トランジスタ	01
△ Q113	VV556400	TR	2SC2412K Q, R, S		トランジスタ	01
△ Q114	VV556400	TR	2SC2412K Q, R, S		トランジスタ	01
Q115	VV556400	TR	2SC2412K Q, R, S		トランジスタ	01
Q116	VV556400	TR	2SC2412K Q, R, S		トランジスタ	01
* △ Q117	WB752700	FET	STP20NM50		F E T	
* △ Q118	WB752700	FET	STP20NM50		F E T	
* △ Q119	WB752700	FET	STP20NM50		F E T	
* △ Q120	WB752700	FET	STP20NM50		F E T	
* Q122	WC021400	FET	STP20NM50FP		F E T	
* Q123	WC021400	FET	STP20NM50FP		F E T	
Q125	VV655400	TR. DGT	DTC114EKA		デジタルトランジスタ	01
* △ Q126	V8234000	TR	1MBK50D 600V		トランジスター	09
* △ Q127	V8234000	TR	1MBK50D 600V		トランジスター	09
Q128	VV556500	TR	2SA1037K Q, R, S		トランジスタ	01
Q129	VV556500	TR	2SA1037K Q, R, S		トランジスタ	01
Q130	VV556500	TR	2SA1037K Q, R, S		トランジスタ	01
Q131	VV556500	TR	2SA1037K Q, R, S		トランジスタ	01
Q132	VV556400	TR	2SC2412K Q, R, S		トランジスタ	01
Q133	VV556400	TR	2SC2412K Q, R, S		トランジスタ	01
Q134	VV556400	TR	2SC2412K Q, R, S		トランジスタ	01
Q135	VV556400	TR	2SC2412K Q, R, S		トランジスタ	01
Q136	VV556500	TR	2SA1037K Q, R, S		トランジスタ	01
Q137	VV556400	TR	2SC2412K Q, R, S		トランジスタ	01
* Q138	WB520400	FET. CHP	2SK2823		チップ F E T	
R102	HV754100	R. CAR. FP	10Ω 1/4W		不燃化カーボン抵抗	01
* R111	VL879500	R. CAR	120KΩ 1/3W		カーボン抵抗	01
R113	HV758220	R. CAR. FP	220KΩ 1/4W		不燃化カーボン抵抗	01
* R114	VL878100	R. CAR	4.7KΩ 1/3W		カーボン抵抗	01
R121	HV758220	R. CAR. FP	220KΩ 1/4W		不燃化カーボン抵抗	01
* R122	VL879800	R. CAR	220KΩ 1/3W		カーボン抵抗	01
* R123	VL879900	R. CAR	270KΩ 1/3W		カーボン抵抗	01
R155	HV755180	R. CAR. FP	180Ω 1/4W		不燃化カーボン抵抗	01
R156	HV755180	R. CAR. FP	180Ω 1/4W		不燃化カーボン抵抗	01
△ R165	HV754330	R. CAR. FP	33Ω 1/4W		不燃化カーボン抵抗	01
△ R166	HV754330	R. CAR. FP	33Ω 1/4W		不燃化カーボン抵抗	01
* R181	WB785200	R. MTL	39Ω 1W		酸化金属被膜抵抗	
* R183	WB785200	R. MTL	39Ω 1W		酸化金属被膜抵抗	
R187	VP939900	R. MTL. OXD	15Ω 1W		酸化金属被膜抵抗	01
R188	VP939900	R. MTL. OXD	15Ω 1W		酸化金属被膜抵抗	01
R189	VP939900	R. MTL. OXD	15Ω 1W		酸化金属被膜抵抗	01
R190	VP939900	R. MTL. OXD	15Ω 1W		酸化金属被膜抵抗	01
* R195	WB805000	R. WW	0.025Ω 15W		セメント抵抗	
* R196	WB805000	R. WW	0.025Ω 15W		セメント抵抗	
R199	HL326470	R. MTL. OXD	4.7KΩ 2W		酸化金属被膜抵抗	01
* R201	WB804900	R. WW	0.012Ω 15W		セメント抵抗	
R203	HV753470	R. CAR. FP	4.7Ω 1/4W		不燃化カーボン抵抗	01
R204	HV753470	R. CAR. FP	4.7Ω 1/4W		不燃化カーボン抵抗	01
R215	VZ370200	R. WW	0.1Ω 5W		セメント抵抗	01
R216	VZ370200	R. WW	0.1Ω 5W		セメント抵抗	01
R221	HV754100	R. CAR. FP	10Ω 1/4W		不燃化カーボン抵抗	01
R222	HV754100	R. CAR. FP	10Ω 1/4W		不燃化カーボン抵抗	01

* New Parts * 新規部品(マーク#の部品は、基板に含まれません)

P.C.B. MAIN & Chip Parts

Schm Ref.	PART NO.	Description	Remarks	Markets	部 品 名	Rank
R223	HV753470	R. CAR. FP	4.7Ω 1/4W		不燃化カーボン抵抗	01
R228	HV758220	R. CAR. FP	220KΩ 1/4W		不燃化カーボン抵抗	
R229	HV758220	R. CAR. FP	220KΩ 1/4W		不燃化カーボン抵抗	
R244	HV756100	R. CAR. FP	1KΩ 1/4W		不燃化カーボン抵抗	01
R245	HV756100	R. CAR. FP	1KΩ 1/4W		不燃化カーボン抵抗	01
R250	HL326560	R. MTL. OXD	5.6KΩ 2W		酸化金属被膜抵抗	01
R258	VP941400	R. MTL. OXD	3.3KΩ 1W		酸化金属被膜抵抗	01
R259	VP941400	R. MTL. OXD	3.3KΩ 1W		酸化金属被膜抵抗	01
R260	VP941400	R. MTL. OXD	3.3KΩ 1W		酸化金属被膜抵抗	01
△ R271	HV753100	R. CAR. FP	1Ω 1/4W		不燃化カーボン抵抗	01
△ R272	HV753100	R. CAR. FP	1Ω 1/4W		不燃化カーボン抵抗	01
R274	VP940400	R. MTL. OXD	100Ω 1W		酸化金属被膜抵抗	01
R275	VP940400	R. MTL. OXD	100Ω 1W		酸化金属被膜抵抗	01
R276	VP939800	R. MTL. OXD	10Ω 1W		酸化金属被膜抵抗	01
R277	VP939800	R. MTL. OXD	10Ω 1W		酸化金属被膜抵抗	01
R278	VP939800	R. MTL. OXD	10Ω 1W		酸化金属被膜抵抗	01
R279	VP939800	R. MTL. OXD	10Ω 1W		酸化金属被膜抵抗	01
R280	VP939800	R. MTL. OXD	10Ω 1W		酸化金属被膜抵抗	01
R281	VP939800	R. MTL. OXD	10Ω 1W		酸化金属被膜抵抗	01
* △ T101	X4035A00	TRANS. PWR		J	電源トランス	
* △ T101	X4180A00	TRANS. PWR		UCTKABG	電源トランス	
TP301	VE340300	PIN. TEST	IRS-1169		テストポイントピン	01
TP302	VE340300	PIN. TEST	IRS-1169		テストポイントピン	01
TP303	VE340300	PIN. TEST	IRS-1169		テストポイントピン	01
TP304	VE340300	PIN. TEST	IRS-1169		テストポイントピン	01
TP305	VE340300	PIN. TEST	IRS-1169		テストポイントピン	01
	EP600190	SCR. BND. HD	3x8 MFZN2BL		バインドBタイトネジ	01
	US034470	C. CE. M. CHP	0.047uF 16V		チップセラコン	01
	US044220	C. CE. M. CHP	0.022uF 25V		チップセラコン	01
	US061100	C. CE. M. CHP	10pF 50V		チップセラコン	01
	US061220	C. CE. M. CHP	22pF 50V		チップセラコン	01
	US061680	C. CE. CHP	68pF 50V		チップセラコン	01
	US061820	C. CE. CHP	82pF 50V		チップセラ (S L)	01
	US062100	C. CE. M. CHP	100pF 50V		チップセラコン	01
	US062150	C. CE. CHP	150pF 50V		チップセラコン	01
	US062330	C. CE. M. CHP	330pF 50V		チップセラコン	01
	US062470	C. CE. M. CHP	470pF 50V		チップセラコン	01
	US063100	C. CE. M. CHP	1000pF 50V		チップセラコン	01
	US064100	C. CE. M. CHP	0.01uF 50V		チップセラコン	01
	US135100	C. CE. CHP	0.1uF 16V		チップセラコン	01
	RD350000	R. CHP	0Ω 1/16W		チップ抵抗	01
	RD353220	R. CHP	2.2Ω 1/16W		チップ抵抗	01
	RD353470	R. CHP	4.7Ω 1/16W		チップ抵抗	01
	RD354270	R. CHP	27Ω 1/16W		チップ抵抗	01
	RD354470	R. CHP	47Ω 1/16W		チップ抵抗	01
	RD355100	R. CHP	100Ω 1/16W		チップ抵抗	01
	RD355220	R. CHP	220Ω 1/16W		チップ抵抗	01
	RD356100	R. CHP	1KΩ 1/16W		チップ抵抗	01
	RD356180	R. CHP	1.8KΩ 1/16W		チップ抵抗	01
	RD356220	R. CHP	2.2KΩ 1/16W		チップ抵抗	01

* New Parts * 新規部品(マーク#の部品は、基板に含まれません)

Chip Parts

Schm Ref.	PART NO.	Description	Remarks	Markets	部 品 名	Rank
	RD356240	R,CHP	2.4KΩ	1/16W	チップ抵抗	01
	RD356330	R,CHP	3.3KΩ	1/16W	チップ抵抗	01
	RD356360	R,CHP	3.6KΩ	1/16W	チップ抵抗	01
	RD356470	R,CHP	4.7KΩ	1/16W	チップ抵抗	01
	RD356510	R,CHP	5.1KΩ	1/16W	チップ抵抗	01
	RD356560	R,CHP	5.6KΩ	1/16W	チップ抵抗	01
	RD356910	R,CHP	9.1KΩ	1/16W	チップ抵抗	01
	RD357100	R,CHP	10KΩ	1/16W	チップ抵抗	01
	RD357120	R,CHP	12KΩ	1/16W	チップ抵抗	01
	RD357150	R,CHP	15KΩ	1/16W	チップ抵抗	01
	RD357180	R,CHP	18KΩ	1/16W	チップ抵抗	01
	RD357220	R,CHP	22KΩ	1/16W	チップ抵抗	01
	RD357330	R,CHP	33KΩ	1/16W	チップ抵抗	01
	RD357360	R,CHP	36KΩ	1/16W	チップ抵抗	01
	RD357390	R,CHP	39KΩ	1/16W	チップ抵抗	01
	RD357470	R,CHP	47KΩ	1/16W	チップ抵抗	01
	RD357750	R,CHP	75KΩ	1/16W	チップ抵抗	01
	RD358100	R,CHP	100KΩ	1/16W	チップ抵抗	01
	RD358120	R,CHP	120KΩ	1/16W	チップ抵抗	01
	RD358150	R,CHP	150KΩ	1/16W	チップ抵抗	01
	RD358220	R,CHP	220KΩ	1/16W	チップ抵抗	01
*	RD358300	R,CHP	300KΩ	1/16W	チップ抵抗	01
	RD358470	R,CHP	470KΩ	1/16W	チップ抵抗	01
	RD359100	R,CHP	1MΩ	1/16W	チップ抵抗	01
	Vi192500	R,MTL,CHP	100Ω	1/10W	チップ金被抵抗	01
	Vi193300	R,MTL,CHP	220Ω	1/10W	チップ金被抵抗	01
*	Vi193700	R,MTL,CHP	330Ω	1/10W	チップ金被抵抗	01
	Vi193900	R,MTL,CHP	390Ω	1/10W	チップ金被抵抗	01
	Vi194700	R,MTL,CHP	820Ω	1/10W	チップ金被抵抗	01
	Vi194900	R,MTL,CHP	1KΩ	1/10W	チップ金被抵抗	01
	Vi195100	R,MTL,CHP	1.2KΩ	1/10W	チップ金被抵抗	01
	Vi195300	R,MTL,CHP	1.5KΩ	1/10W	チップ金被抵抗	01
	Vi195500	R,MTL,CHP	1.8KΩ	1/10W	チップ金被抵抗	01
	Vi195700	R,MTL,CHP	2.2KΩ	1/10W	チップ金被抵抗	01
	Vi195900	R,MTL,CHP	2.7KΩ	1/10W	チップ金被抵抗	01
	Vi196000	R,MTL,CHP	3KΩ	1/10W	チップ金被抵抗	01
	Vi196100	R,MTL,CHP	3.3KΩ	1/10W	チップ金被抵抗	01
	Vi196400	R,MTL,CHP	3.9KΩ	1/10W	チップ金被抵抗	01
	Vi196600	R,MTL,CHP	4.7KΩ	1/10W	チップ金被抵抗	01
	Vi196800	R,MTL,CHP	5.6KΩ	1/10W	チップ金被抵抗	01
	Vi197000	R,MTL,CHP	6.8KΩ	1/10W	チップ金被抵抗	01
	Vi197200	R,MTL,CHP	8.2KΩ	1/10W	チップ金被抵抗	01
*	Vi197400	R,MTL,CHP	10KΩ	1/10W	チップ金被抵抗	01
	Vi198100	R,MTL,CHP	20KΩ	1/10W	チップ金被抵抗	01
	Vi198200	R,MTL,CHP	22KΩ	1/10W	チップ金被抵抗	01
	Vi198400	R,MTL,CHP	27KΩ	1/10W	チップ金被抵抗	01
*	Vi198800	R,MTL,CHP	39KΩ	1/10W	チップ金被抵抗	01
	Vi199200	R,MTL,CHP	56KΩ	1/10W	チップ金被抵抗	01
	Vi200000	R,MTL,CHP	100KΩ	1/10W	チップ金被抵抗	01
*	VK581400	R,MTL,CHP	150KΩ	1/10W	チップ金被抵抗	01
*	VK581600	R,MTL,CHP	180KΩ	1/10W	チップ金被抵抗	01
*	VK581800	R,MTL,CHP	220KΩ	1/10W	チップ金被抵抗	01
	VK582200	R,MTL,CHP	330KΩ	1/10W	チップ金被抵抗	01

* New Parts * 新規部品(マーク#の部品は、基板上に含まれません)

Chip Parts

Schm Ref.	PART NO.	Description	Remarks	Markets	部 品 名	Rank
*	VK582700	R,MTL,CHP	510KΩ	1/10W	チップ金被抵抗	01
	VK583400	R,MTL,CHP	1MΩ	1/10W	チップ金被抵抗	01

* New Parts * 新規部品(マーク#の部品は、基板上に含まれません)

MX-D1

EXPLODED VIEW

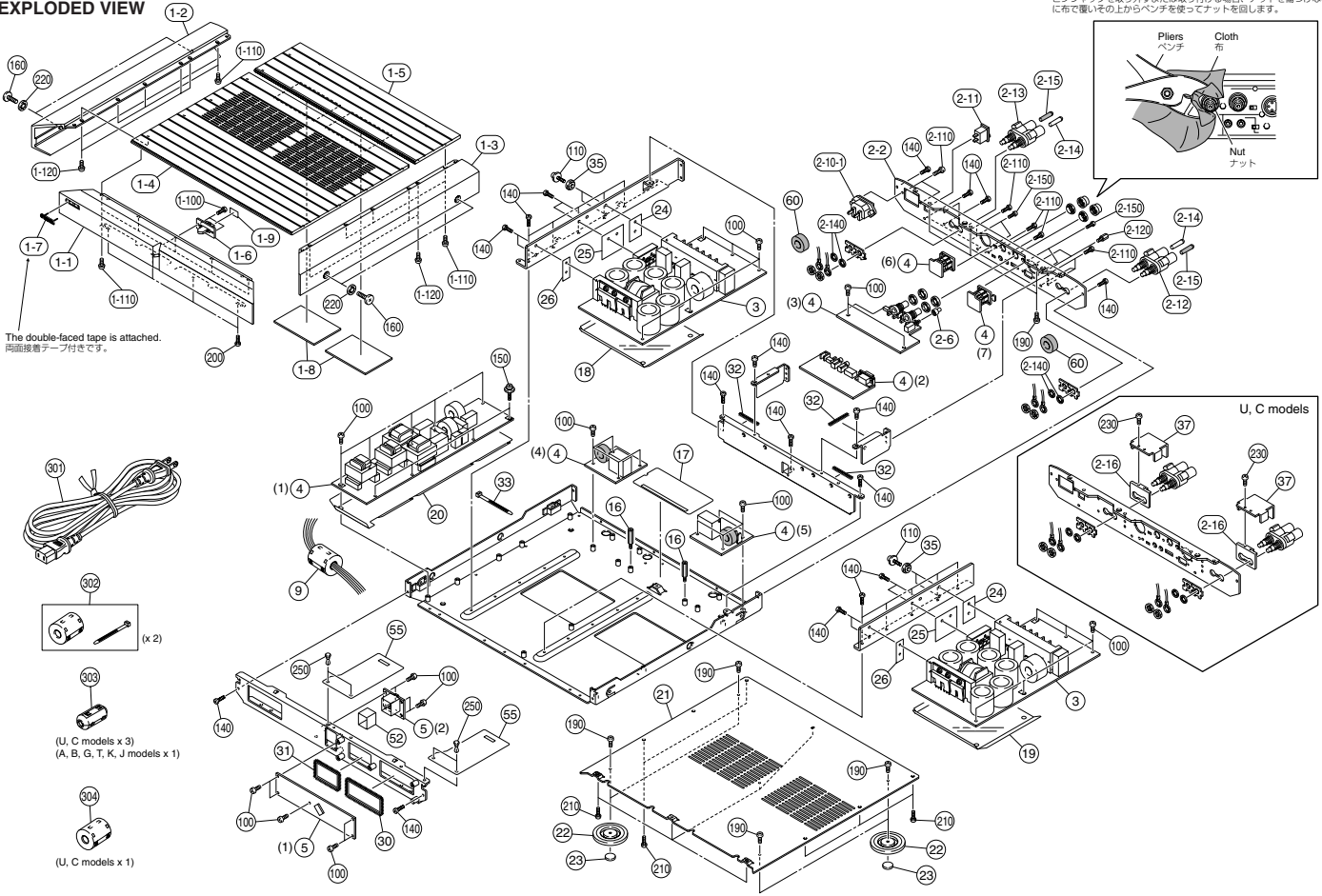

The double-faced tape is attached.
両面接着テープ付です。

When removing or installing the pin jack, cover the nut with cloth and turn it with pliers so as not to cause damage to it.
ピンジャックを取り外すまたは取り付ける場合、ナットを傷つけないように布で覆いその上からペンチを使ってナットを回します。

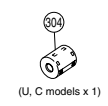
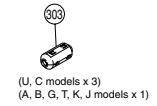
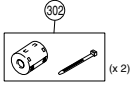
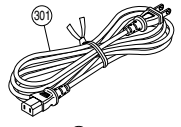
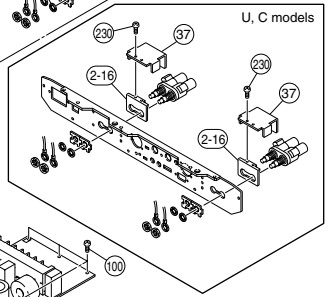
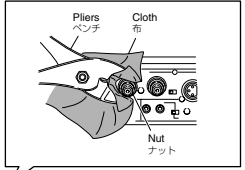

MECHANICAL PARTS

Schm Ref.	PART NO.	Description	Remarks	Markets	部品名	Rank
*	1-1	WC342900	FRONT PANEL		フロントパネル	
*	1-2	WC343000	SIDE PANEL L		サイドパネル L	
*	1-3	WC343100	SIDE PANEL R		サイドパネル R	
*	1-4	WB373000	TOP PANEL F		トップパネル F	
*	1-5	WB374000	TOP PANEL R		トップパネル R	
*	1-6	WB386500	BUTTON ASS'Y		ボタンアッセイ	
*	1-7	V6004800	EMBLEM		エンブレム	
*	1-8	WB964600	DAMPER/T2	BL	ダンパ/T2	03
*	1-9	WC372500	SHEET/DIFFUSION		シート/カクサン	
*	1-100	EP00190	BIND HEAD B-TIGHT SCREW	3x8	MFNZBL	01
*	1-110	V5363000	SCREW MACHINE	3x6	MFNZBL	01
*	1-120	V03193000	BIND HEAD SCREW	3x6	MFC2CU	
*	2-2	WB336000	REAR PANEL	J	リヤパネル	
*	2-2	WB336100	REAR PANEL	UC	リヤパネル	
*	2-2	WB336200	REAR PANEL	A	リヤパネル	
*	2-2	WB336300	REAR PANEL	BG	リヤパネル	
*	2-2	WB336400	REAR PANEL	T	リヤパネル	
*	2-2	WB336500	REAR PANEL	K	リヤパネル	
*	2-6	V6001900	BUTTON D5	BL	ボタン D5	
*	2-10-1	WB933000	AC INLET 2P	R-30190	ACインレット 2P	03
*	2-11	WB577300	SEESAW SWITCH	JNZ1120-0301CK	ローカーSW	
*	2-12	WC025900	SPEAKER TERMINAL	WBT-0735 RE	スピーカーターミナル	
*	2-13	WB327000	SPEAKER TERMINAL	WBT-0735 WH	スピーカーターミナル	
*	2-14	WC127900	SAFETY STICK	WBT-0799MH	安全ピン	
*	2-15	WC362500	SAFETY STICK	WBT-0799ME	安全ピン	
*	2-16	WD071500	SUPPORT COVER	UC	サポートカバー	
*	2-110	VZ537900	BIND HEAD BONDING B-T. SCREW	3x8	MFC2	01
*	2-120	V3766900	SCREW LOCK	17L-003C41	ロックネジ	01
*	2-140	ET900040	TOOTH LOCKED WASHER	9, 0	歯付歯金内歯形	02
*	2-150	WC378200	SCREW MACHINE	2, 6x6	MFNZBL	
*	3	WB375900	P.C.B. ASS'Y	J	P.C.B. メイン	
*	3	WB376000	P.C.B. ASS'Y	UC	P.C.B. メイン	
*	3	WB376100	P.C.B. ASS'Y	TKABG	P.C.B. メイン	
*	3	WB376200	P.C.B. ASS'Y	J	P.C.B. 集積ファンク	
*	3	WB376300	P.C.B. ASS'Y	UC	P.C.B. 集積ファンク	
*	3	WB376400	P.C.B. ASS'Y	TKABG	P.C.B. 集積ファンク	
*	3	WB376500	P.C.B. ASS'Y	JUC	P.C.B. オペレーション	
*	3	WB376600	P.C.B. ASS'Y	TKABG	P.C.B. オペレーション	
*	9	VW910400	CLAMP FILTER	ZCAT3035-1330	クランプフィルタ	
*	16	WC202300	SPACER	BSB-318-6	スペーサ	
*	17	WB355900	SHEET/INS		絶縁シート	
*	18	WB336000	SHEET/INS-L		絶縁シート/L	
*	19	WB336100	SHEET/INS-R		絶縁シート/R	
*	20	WB336200	SHEET/INS-PWR		絶縁シート/PWR	
*	21	WB335800	BOTTOM COVER		ボトムカバー	
*	22	WC361600	LEG		レッグ	
*	23	WB376700	LEG/PAD		レッグ/パッド	
*	24	WB336300	SHEET	E-1437	シート/放熱	
*	25	WB336400	SHEET	E-1438	シート/放熱	
*	26	WB336500	SHEET	E-1439	シート/放熱	
*	30	WB965300	JIZAI BUSH/L	KG-010 L193	ジザイブッシュ	
*	31	WB965400	JIZAI BUSH	KG-010 L142	ジザイブッシュ	
*	32	WC048600	JIZAI BUSH	KG-010 L45	ジザイブッシュ	
*	33	CB069250	BINDING TIE	BK-1	束縛止め	01

* New Parts * 新規部品(マーク#の部品は、基板に含まれません)

Schm Ref.	PART NO.	Description	Remarks	Markets	部品名	Rank
*	35	WB396400	SHOULDER WASHER	BIVAR SW-031-145	ショルダーワッシャー	
*	37	WD071400	COVER		カバー	
*	52	WC213600	SHEET/REF		シート/バリヤ	
*	55	WC503000	SHEET		シート/バリヤ	
*	60	WB333000	FERRITE CORE	9P53R6310190ND	フェライトコア	04
*	100	V0319300	BIND HEAD SCREW	3x6	MFC2CU	
*	110	VK697900	BIND HEAD B-TIGHT SCREW	3x10 SP	MFC2NY	01
*	140	VZ537900	BIND HEAD BONDING B-T. SCREW	3x8	MFC2	01
*	150	VT669300	PN HEAD B-TIGHT SCREW	3x8-8	MFC2	01
*	160	V6012200	FLAT FILLISTER HEAD SCREW	4x12-10	MFCZBL	01
*	190	V5363000	SCREW MACHINE	3x6	MFNZBL	01
*	200	VD049800	BIND HEAD BONDING B-T. SCREW	3x10	MFNZBL	01
*	210	VR144900	BIND HEAD BONDING B-T. SCREW	3x6	MFNZBL	01
*	220	ET900050	TOOTHED LOCK WASHER	4, 0	MFCZBL	01
*	230	EP600230	BIND HEAD B-TIGHT SCREW	3x6	MFNZBL	01
*	250	CB099600	PLASTIC RIVET	No. 920	プラスチックリベット	03
					付属品	
*	301	WC593700	POWER CABLE	INLET 2m	J	電源コード
*	301	V8467000	POWER CABLE	INLET 2m	UC	電源コード
*	301	V3358400	POWER CABLE	INLET 2m	T	電源コード
*	301	WB750900	POWER CABLE	INLET 2m	A	電源コード
*	301	WB751000	POWER CABLE	INLET 2m	B	電源コード
*	301	V6545900	POWER CABLE	INLET 2m	B	電源コード
*	302	WC70900	CLAMP FILTER	1pc with fixing tie	for POWER CABLE	07
*	303	VW910300	CLAMP FILTER	1pc ZCAT2035-0930A	for RS232C CONTROL	05
*	304	VW910400	CLAMP FILTER	1pc ZCAT3035-1330	for PIN CABLE	07

* New Parts * 新規部品(マーク#の部品は、基板に含まれません)

MX-D1

■ HEATSINK/AMP

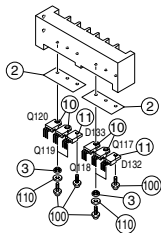

Schm Ref.	PART NO.	Description	Remarks	Markets	部品名	Rank
2	W661500	SHEET	BFG-20 (K-4480)		シート/放熱	
3	W6936400	SHOULDER WASHER	B1VAR SM-031-145		ショルダーワッシャ	
10	W6752700	FET	STP20NM60	Q117-Q120	F E T	
11	W6687000	SCROTTKY DIODE	SF20SC4 20A 40V	D132, D133	ショットキダイオード	01
100	W0121100	SEMS BIND HEAD B-TIGHT SCREW	3x10 MFXZNBZL		セムスバインドBタイト	
110	VA214300	PLAIN WASHER	3x6x0.5 MFXZNBZL		平座金こがた丸	

* New Parts * 新規部品

■ HEATSINK/PWR

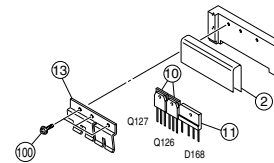

Schm Ref.	PART NO.	Description	Remarks	Markets	部品名	Rank
2	W0000000	SHEET, RADIATOR			シート/放熱	
10	V8234000	TRANSISTOR	1MBK50D 600V	Q126, Q127	トランジスタ	09
11	W6730100	DIODE BRIDGE	LN25X860 25A 600V	D168	ダイオードスタック	
13	W0000200	SUPPORT/TR			サポート/TR	
100	V5848200	CUP B-TIGHT SCREW	3x10 MFXZNBZL		カップBタイト	01

* New Parts * 新規部品

■ HEATSINK/BRG

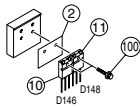

Schm Ref.	PART NO.	Description	Remarks	Markets	部品名	Rank
2	V6492000	RADIATION SHEET	BFG-20ADH-6 24X36		シート 放熱	02
10	V8498700	DIODE	FMU-36R 20.0A 600V	D148	ダイオード	04
11	W3995000	DIODE BRIDGE	FMU-36S 20.0A 600V	D146	D I スタック	05
100	W1732000	SCREW, TRANSISTOR	3x15 SP MFC2		スクリューTR	01

* New Parts * 新規部品